

Mounting Surface : ISO 4401-AB-03-4-A, CETOP-3, NFPA-D01

Up to 31.5 MPa (4570 PSI), 35 L/min (9.25 U.S.GPM)

The modular valves are functional elements with which a hydraulic system can be composed and built easily by stacking them with the mounting bolts. Therefore, no piping is required for the manufacture of the hydraulic systems. Yuken's 01 Series Modular Valves are widely used to compose the hydraulic systems for the various industrial equipment including machine tools, special purpose machines and injection moulding machines.

The valves have standardized mounting surface conforming to ISO 4401-AB-03-4-A and optimum thickness for the stacking.



■ Example of Stacking Configuration

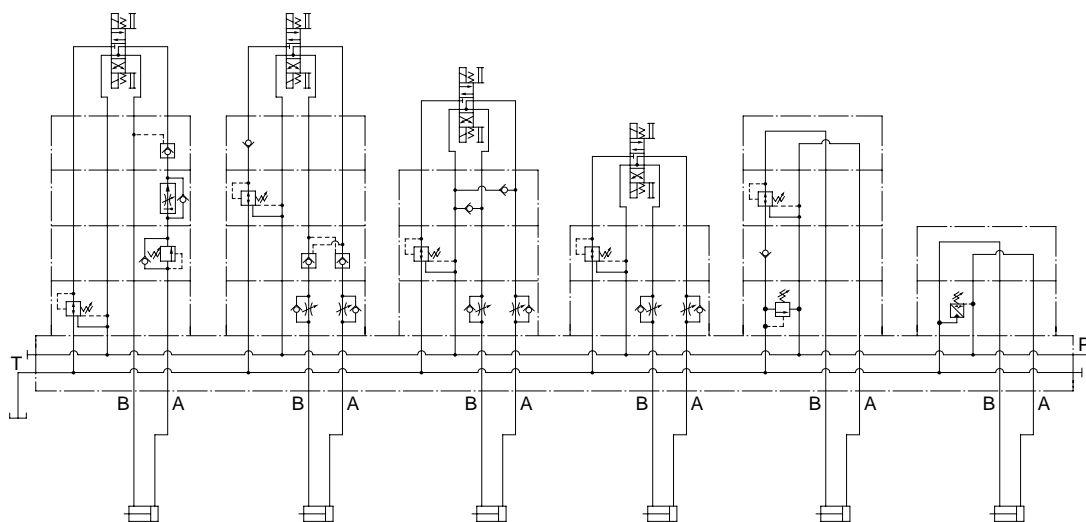

1/8, Solenoid Operated Directional Valve (DSG-01)

Modular Valves

Base Plate (MMC-01)

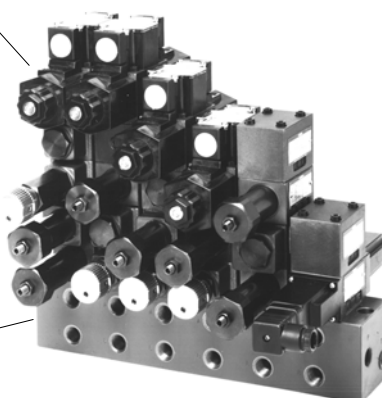











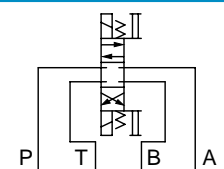

Type of Modular Valve

Class	Model Numbers	Graphic Symbols	Page	Class	Model Numbers	Graphic Symbols				Page
						P	T	B	A	
	Solenoid Operated Directional Valve (S-)DSG-01-***-60/6090 T-DSG-01-***-60 G-DSG-01-***-50/5090		★		Flow Control Valves (for "P-Line") MFP-01-10/1090					22
					Flow Control and Check Valves (for "A-Line", Metre-out) MFA-01-X-10/1090					22
					Flow Control and Check Valves (for "A-Line", Metre-in) MFA-01-Y-10/1090					22
					Flow Control and Check Valves (for "B-Line", Metre-out) MFB-01-X-10/1090					22
					Flow Control and Check Valves (for "B-Line", Metre-in) MFB-01-Y-10/1090					22
					Flow Control and Check Valves (for "A&B-Lines", Metre-out) MFW-01-X-10/1090					22
					Flow Control and Check Valves (for "A&B-Lines", Metre-in) MFW-01-Y-10/1090					22
					Temperature Compensated Throttle and Check Valves (for "A-Line", Metre-out) MSTA-01-X-10/1090					26
					Temperature Compensated Throttle and Check Valves (for "B-Line", Metre-out) MSTB-01-X-10/1090					26
					Temperature Compensated Throttle and Check Valves (for "A&B-Lines", Metre-out) MSTW-01-X-10/1090					26
					Throttle Valves (for "P-Line") MSP-01-50/5090					30
					Check and Throttle Valves (for "P-Line") MSCP-01-30/3090					32
					Throttle and Check Valves (for "A-Line", Metre-out) MSA-01-X-50/5090					34
					Throttle and Check Valves (for "A-Line", Metre-in) MSA-01-Y-50/5090					34
					Throttle and Check Valves (for "B-Line", Metre-out) MSB-01-X-50/5090					34
					Throttle and Check Valves (for "B-Line", Metre-in) MSB-01-Y-50/5090					34
					Throttle and Check Valves (for "A&B-Lines", Metre-out) MSW-01-X-50/5090					34
					Throttle and Check Valves (for "A&B-Lines", Metre-in) MSW-01-Y-50/5090					34
					Throttle and Check Valves (for "A&B-Lines", Metre-out, Metre-in) MSW-01-XY-50/5090					34
					Throttle and Check Valves (for "A&B-Lines", Metre-in, Metre-out) MSW-01-YX-50/5090					34
Pressure Control Valves	Relief Valves (for "P-Line") MBP-01-**-30/3090		7							
	Relief Valves (for "A-Line") MBA-01-**-30/3090		7							
	Relief Valves (for "B-Line") MBB-01-**-30/3090		7							
	Reducing Valves (for "P-Line") MRP-01-**-30/3090		10							
	Reducing Valves (for "A-Line") MRA-01-**-30/3090		10							
	Reducing Valves (for "B-Line") MRB-01-**-30/3090		10							
	Brake Valves MBR-01-**-30/3090		13							
	Sequence Valves (for "P-Line") MHP-01-**-30/3090		15							
	Counterbalance Valves (for "A-Line") MHA-01-**-30/3090		15							
	Pressure Switches Valves (for "P-Line") MJP-01-M-**-10/1090		18							
	Pressure Switches Valves (for "A-Line") MJA-01-M-**-10/1090		18							
	Pressure Switches Valves (for "B-Line") MJB-01-M-**-10/1090		18							

★ For the details of solenoid operated directional valves, see the following catalogues:

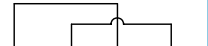
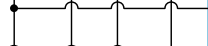
- (S-)DSG-01-***-60/6090 } Pub.EC-0402
- T-DSG-01-***-60 } Pub.EC-0402
- G-DSG-01-***-50/5090 : Pub.EC-0405

■ Type of Modular Valve

Class	Model Numbers	Graphic Symbols	Page
	Solenoid Operated Directional Valve (S-)DSG-01-***-60/6090 T-DSG-01-***-60 G-DSG-01-***-50/5090		★
Directional Control Valves	Check Valves (for "P-Line") MCP-01-*-*30/3090		38
	Check Valves (for "T-Line") MCT-01-*-*30/3090		38
	Anti-Cavitation Valves MAC-01-30/3090		39
	Pilot Operated Check Valves (for "A-Line") MPA-01-*-*40/4090		40
	Pilot Operated Check Valves (for "B-Line") MPB-01-*-*40/4090		40
	Pilot Operated Check Valves (for "A&B-Lines") MPW-01-*-*40/4090		40
Modular Plates and Mounting Bolts	End Plates (Blocking plates) MDC-01-A-30/3090		42
	End Plates (Bypass plates) MDC-01-B-30/3090		42
	Connecting Plates (for "P&A-Lines") MDS-01-PA-30/3090		43
	Connecting Plates (for "P&B-Lines") MDS-01-PB-30/3090		43
	Connecting Plates (for "A&T-Lines") MDS-01-AT-30/3090		43
	Base Plates MMC-01-*-*40/4080/4090		44
	Bolt Kits MBK-01-*-*30/3090		47

★ For the details of solenoid operated directional valves, see the following catalogues:

(S-)DSG-01-***-60/6090 } Pub.EC-0402
 T-DSG-01-***-60 }
 G-DSG-01-***-50/5090 : Pub.EC-0405

F

Instructions

Caution in the selection of valves and circuit designing

The selection of modular valves, to suit a particular function or hydraulic circuit, are made in exactly the same way as conventional valves, taking into account of the flow and pressure of each valve to be used. In some cases, the stacking system may be restricted, so please refer to the following instructions for stacking sequence. Please note, that when designing a system using modular stacking valves, due consideration should be given to working space for future maintenance.

Stacking sequence when using reducing valves (for "A" or "B" line) and pilot operated check valves.

Because reducing valves are spool type, there is an internal leakage. In the stacking sequence shown in the drawing left (incorrect), the cylinder moves due to leakage through the pilot pressure line.

Consequently, retaining the position of the cylinder using a pilot operated check valve becomes impossible. The stacking sequence shown in the drawing right (correct) is required in order to retain the cylinder position.

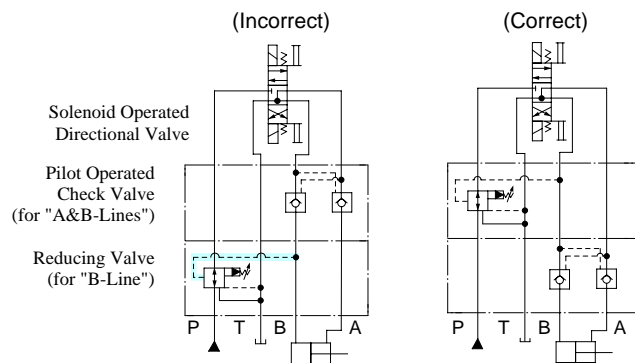

Stacking sequence when using reducing valves (for "A" or "B" line) and throttle and check valves (for metre-out).

In B to T flow in the drawing left (incorrect), pressure is generated at the part with a throttle effect of the throttle and check valve. Depending upon the pressure so generated, the reducing valve may perform a pressure reducing function which causes a shortage of output power of the cylinder and spoils the smooth operation of the cylinder. Therefore, stacking sequence in the drawing right (correct) is required in this combination.

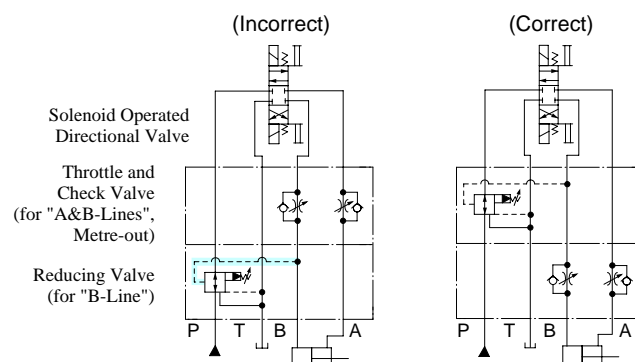

Stacking sequence when using pilot operated check valves and throttle and check valves (metre-out).

In A to T flow in the drawing left (incorrect), pressure is generated at the part with a throttle effect of the throttle and check valve.

The pressure so generated acts to shut the pilot operated check valve and eventually creates an open and shut operation of the valve repeatedly which may cause the cylinder to have a knocking effect (the same effect will occur in the case of B to T flow). Therefore, the stacking sequence in the drawing right (correct) is required in this combination.

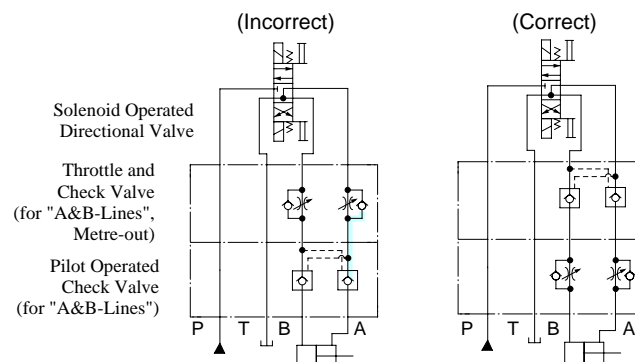

Stacking sequence when using brake valves and throttle and check valves.

In the drawing left (incorrect), pressure is generated at the part (a load pressure and a back pressure from throttle effect). For structural reasons of the brake valve, the load pressure and back pressure act to open the valve, therefore, the setting pressure should be more than the pressure equal to the load pressure plus back pressure ($P_a + P_b$). If the setting pressure is less than $P_a + P_b$, the brake valve acts and brakes the movement of the actuator in operation, this eventually reduces the speed of the actuator.

On the contrary, if the setting pressure is more than $P_a + P_b$, shock may occur when braking the actuator since the setting pressure is too high against the load pressure. Therefore, the stacking sequence in the drawing right (correct) is required in this combination.

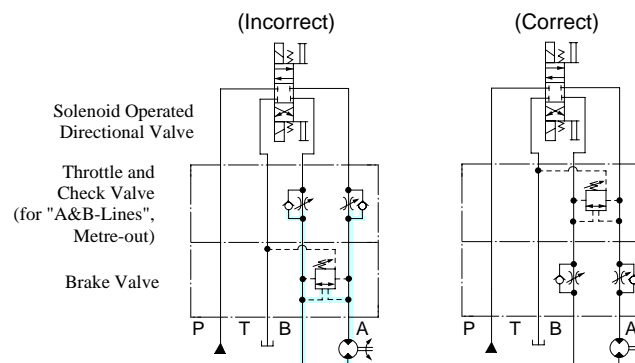

■ Specifications

Max. Operating Pressure 31.5 MPa (4570 PSI)
 Max. Flow 35 L/min (9.25 U.S. GPM) ★¹
 Number of Stack..... 1 to 5 stacks ★²

★ 1. 60 L/min (15.9 U.S.GPM) for throttle modular (MSP) and throttle and check modular (MSA/MSB/MSW) valves.

★ 2. Solenoid operated directional valve is included in the number of stack.

If the working pressure is above 25 MPa (3630 PSI), the maximum number of layers in a stack is 4 including the solenoid operated directional valve.

1/8 Solenoid Operated Directional Valves

YUKEN 01 SERIES MODULAR VALVES are designed for use with solenoid operated directional valve having an ISO 4401-AB-03-4-A (CETOP-3, NFPA-D01) interface such as Yuken's DSG-01. Please refer to the Catalogue No. Pub. EC-0402 for details.

■ Hydraulic Fluids

● Fluid Types

Any type of hydraulic fluid, listed in the table below can be used.

Petroleum base oils	Use fluids equivalent to ISO VG 32 or VG 46.
Synthetic fluids	Use phosphate ester or polyol ester fluid. When phosphate ester fluid is used, prefix "F-" to the model number because the special seals (fluororubber) are required to be used.
Water containing fluids	Use water-glycol fluid.

Note: For use with hydraulic fluids other than those listed above, please consult your Yuken representatives in advance.

● Recommended Viscosity and Temperatures

Always be sure to use hydraulic fluids within the stipulated conditions shown below:

Viscosity: 15 to 400 mm²/s (77 to 1800 SSU), Temperature: -15 to +70°C (5 to 160°F)

● Control of Contamination

Due caution must be paid to maintaining control over contamination of the hydraulic fluids which may otherwise lead to breakdowns and shorten the life of the valve. Please maintain the degree of contamination within NAS 1638-Grade 12. Use 25 μm or finer line filter.

■ Base Plates and Sub-Plates

When mounting the modular valves, use base plates and sub-plates specified below. If these base plates and the sub-plates are not used, ensure that the mounting surface has a good machined finish.

Base Plates		Sub-Plates	
Model Numbers	Page	Model Numbers	Page
MMC-01-* -40/4080/4090	44	DSGM-01-* -30/3080/3090	★

★ For the details of Sub-Plate, see the following DSG-01 solenoid operated directional valve catalogue: Catalogue No. Pub. EC-0402.

■ Mounting Bolts

01 series modular valves are mounted by using stud bolts which are supplied in a kit form. When mounting, see the following table for tightening torque. After the test run, be sure to tighten again firmly with the specified torque.

Bolt Kit Model Numbers	Tightening torque Nm (in. lbs.)
MBK-01-* -30	5-6 (44-53)
MBK-01-* -3090	[6-7 (53-62)] ★

★ Where working pressure is above 25 MPa (3630 PSI), use the tightening torques shown in the parentheses.



■ Assembly

Assembly should be carried out in clean conditions and in accordance with the following procedure. Cautious attention should be paid to ensure that the interface of the valves are clean and free from dirt or other foreign materials.

● Assembly Procedure:

- 1) Screw-in the four stud bolts, fully into the tapped holes on the mounting surface of the specified base plate, sub-plate or manifold.
- 2) Facing the O-ring fitted surfaces to the base plate, stack the modular and solenoid operated directional valves in accordance with the circuit diagram. Use stud bolts, while taking care that the pitches of the mounting holes differ as shown below.

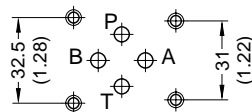

- 3) Align both the end of the valves stacked.
- 4) Screw-in the four nuts onto the stud bolts and tighten with the specified torque. After the test run, be sure to re-tighten the nuts firmly with the specified torque.

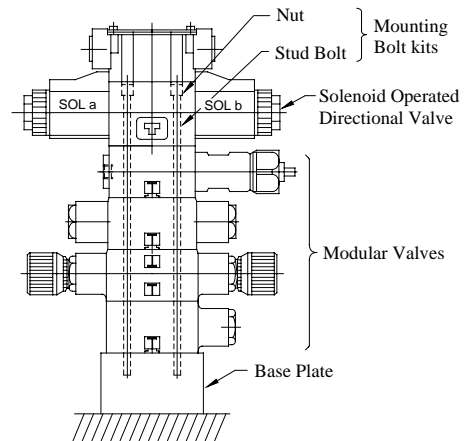

[Example] 01 Series Modular Valves

⚠ CAUTION

- Keep all installation holes and surface clean. Failure to do this may cause fire due to oil leakage.
- Before installing the product, be sure that all specified bolts are tightened to the specified torque levels. Tightening to levels outside specifications may cause improper operation, damage, oil leakage, etc.

■ Pressure Drop

Pressure drop curves of the modular valves are those based on viscosity of 35 mm²/s (164 SSU) and specific gravity of 0.850.

When using the modular valves in conditions other than the above mentioned, find the appropriate values referring to the following table and formula.

- For any other viscosity, multiply the factors in the table below.

Viscosity	mm ² /s	15	20	30	40	50	60	70	80	90	100
	SSU		77	98	141	186	232	278	324	371	417
Factor		0.81	0.87	0.96	1.03	1.09	1.14	1.19	1.23	1.27	1.30

- For any other specific gravity (G'), the pressure drop ($\Delta P'$) may be obtained from the following formula.

$$\Delta P' = \Delta P (G'/0.850)$$

1/8, Relief Valves

For "P" Line: **MBP-01-* -30/3090**
 For "A" Line: **MBA-01-* -30/3090**
 For "B" Line: **MBB-01-* -30/3090**

Specifications / Others

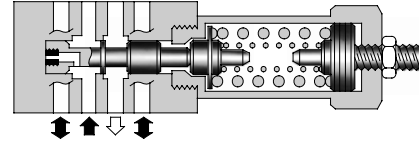
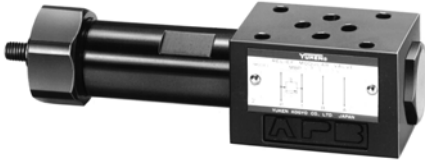

Specifications

Model Numbers	Max. Operating Pressure MPa (PSI)	Max. Flow L/min (U.S.GPM)
MBP-01-* -30/3090 MBA-01-* -30/3090 MBB-01-* -30/3090	21 (3050)	35 (9.25)

Model Number Designation

F-	MBP	-01	-C	-30	*
Special Seals	Series Number	Valve Size	Pres. Adj. Range MPa (PSI)	Design Number	Design Standard
F: Special Seals for Phosphate Ester Type Fluids (Omit if not required)	MBP : Relief Valve for P-Line MBA : Relief Valve for A-Line MBB : Relief Valve for B-Line	01	C : * -14 ^{★1} (* -2030) H : 7-21 (1020-3050)	30	Refer to ^{★2}

★ 1. See the "Minimum Adjustment Pressure" of the next page for the item marked *.

★ 2. Design Standards: None Japanese Standard "JIS" and European Design Standard
 90 N. American Design Standard

Instructions

- The minimum adjustment pressure equals the value obtained from the minimum adjustment pressure characteristics plus the tank line back pressure of the next page. This back pressure should include the value of the T-line pressure drop characteristics of the valves stacked to the base plate side of the modular valve.
- To make pressure adjustment, loosen the lock nut and turn the pressure adjustment screw clockwise or anti-clockwise. For an increase of pressure, turn the screw clockwise. Be sure to re-tighten the lock nut firmly after making adjustment to the pressure.
- In case of a small flow, the setting pressure may become unstable. To avoid this, refer to the minimum flow characteristic curve of the next page and use the valve within a range as shown with .

Graphic Symbols

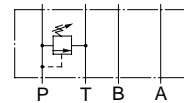

MBP-01

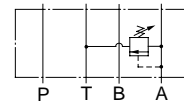

MBA-01

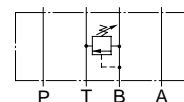

MBB-01

Hydraulic Fluid: Viscosity 35 mm²/s (164 SSU), Specific Gravity 0.850

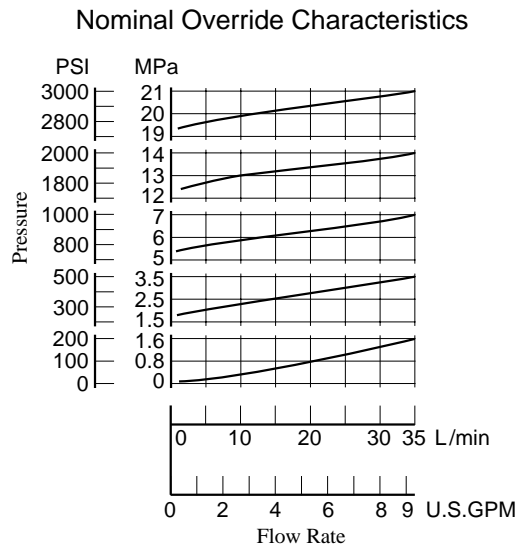
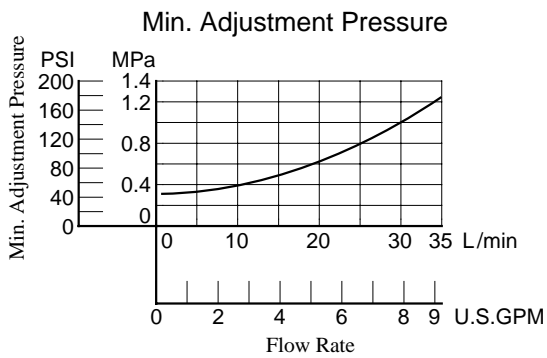
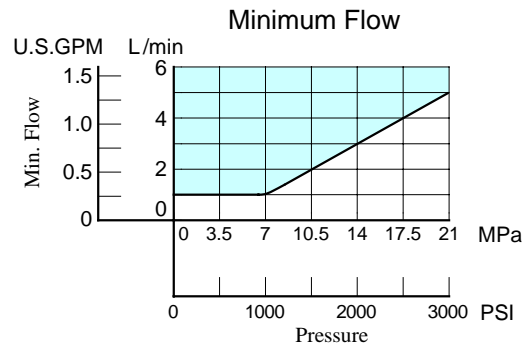
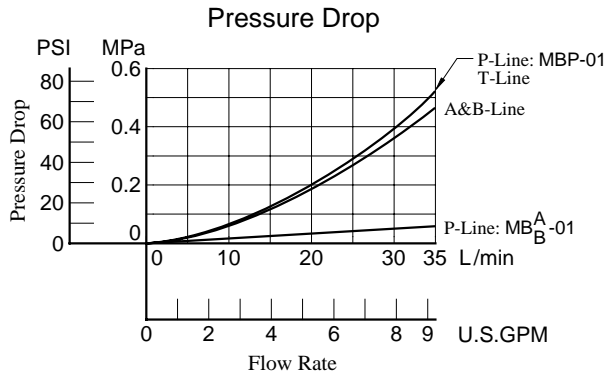

MBP-01-* -30/3090
MBB-01-* -30/3090

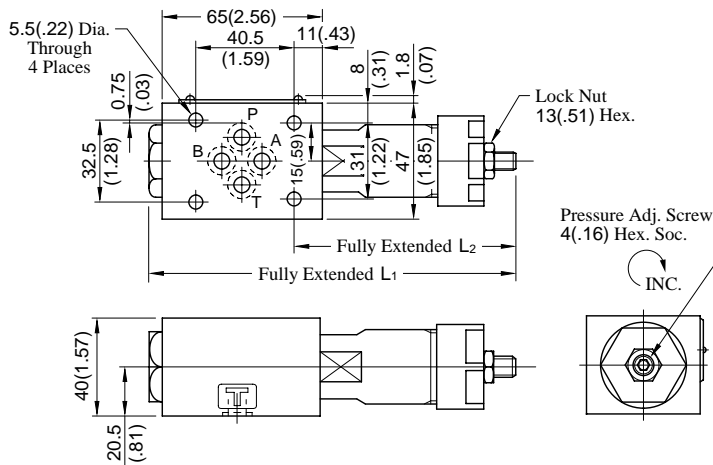

Model No.	L ₁	L ₂
MB*-01-C	151 (5.94)	92 (3.62)
MB*-01-H	166.5 (6.56)	107.5 (4.23)

Approx. Mass..... 1.1 kg (2.4 lbs.)

**DIMENSIONS IN
MILLIMETRES (INCHES)**

MBA-01-* -30/3090

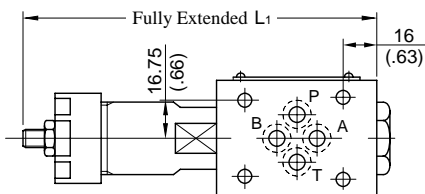

Approx. Mass..... 1.1 kg (2.4 lbs.)

• For other dimensions, refer to above (MBP-01) drawing.

■ Spare Parts List

MBP-01-* -30/3090

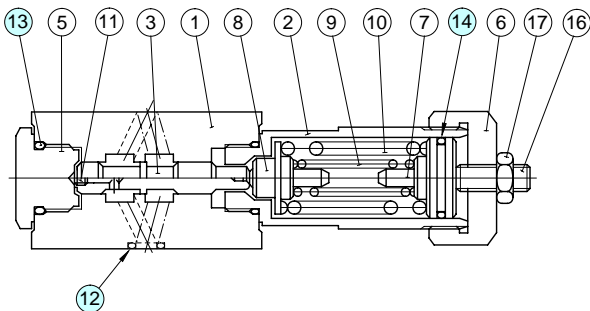

MBA-01-* -30/3090

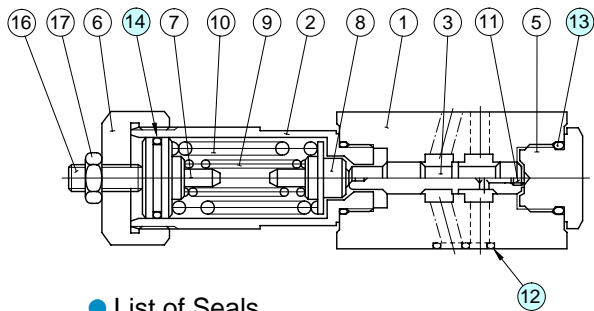

MBB-01-* -30/3090

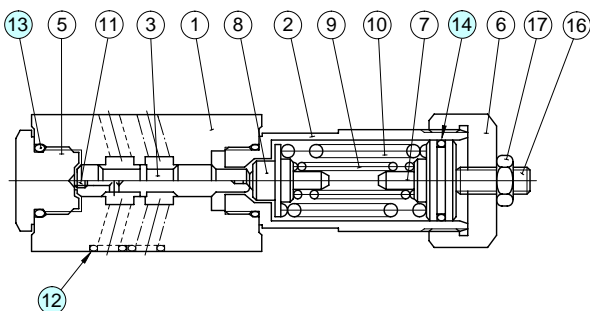

● List of Seals

Item	Name of Parts	Part Numbers	Qty.
12	O-Ring	SO-NB-P9	4
13	O-Ring	SO-NB-P18	2
14	O-Ring	SO-NA-P20	1

Note: When ordering seals, please specify the seal kit number from the table below.

● List of Seal Kit

Model No.	Seal kit No.
MBP-01	KS-MBP-01-30
MBA-01	
MBB-01	

⚠ CAUTION

When making replacement of seals, please do it carefully after reading through the relevant instructions in the Operator's Manual.

1/8, Reducing Valves

For "P" Line: **MRP-01-* -30/3090**
 For "A" Line: **MRA-01-* -30/3090**
 For "B" Line: **MRB-01-* -30/3090**

Specifications / Others

Specifications

Model Numbers	Max. Operating Pressure MPa(PSI)	Max. Flow L/min (U.S.GPM)
MRP-01-* -30/3090 MRA-01-* -30/3090 MRB-01-* -30/3090	31.5 (4570)	35 (9.25) *

★ If the pressure is set below 1.9 MPa (280 PSI), the maximum flow is limited. See the minimum adjustment pressure vs. maximum flow characteristics and during use, stay within the shaded zone on the graph.

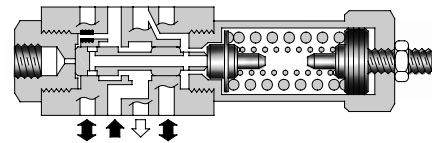

Model Number Designation

F-	MRP	-01	-B	-30	*
Special Seals	Series Number	Valve Size	Pres. Adj. Range MPa (PSI)	Design Number	Design Standard
F: Special Seals for Phosphate Ester Type Fluids (Omit if not required)	MRP: Reducing Valve for P-Line MRA: Reducing Valve for A-Line MRB: Reducing Valve for B-Line	01	B: *-7 (*-1020) * ¹ C: 3.5-14 (510-2030) H: 7-21 (1020-3050)	30	Refer to ★ ²

★ 1. See the "Minimum Adjustment Pressure vs. Maximum Flow" of the next page for the item marked *.

★ 2. Design Standards: None Japanese Standard "JIS" and European Design Standard
 90 N. American Design Standard

Instructions

- The minimum adjustment pressure equals the value obtained from the minimum adjustment pressure characteristics plus the tank line back pressure of the next page. This back pressure should include the value of the T-line pressure drop characteristics of the valves stacked to the base plate side of the modular valve.
- To make pressure adjustment, loosen the lock nut and turn the pressure adjustment screw clockwise or anti-clockwise. For an increase of pressure, turn the screw clockwise. Be sure to re-tighten the lock nut firmly after making adjustment to the pressure.

Graphic Symbols

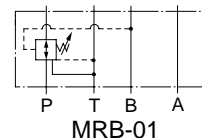
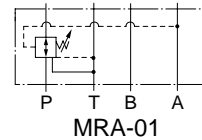
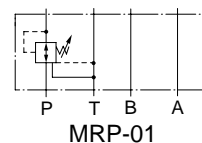

Typical Performance Characteristics

Hydraulic Fluid: Viscosity 35 mm²/s (164 SSU), Specific Gravity 0.850

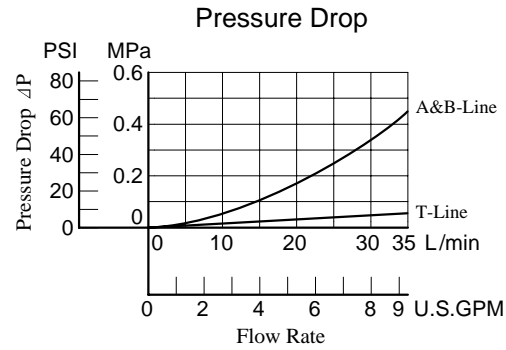

Pres. Drop at Spool Fully Open (P-Line)

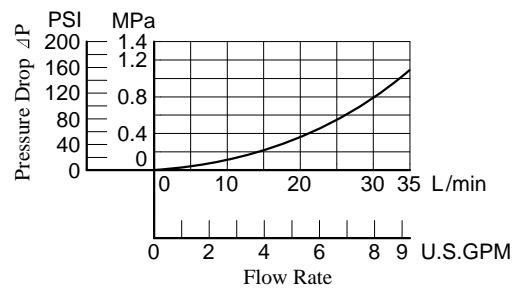

Min. Adjustment Pressure vs. Max. Flow

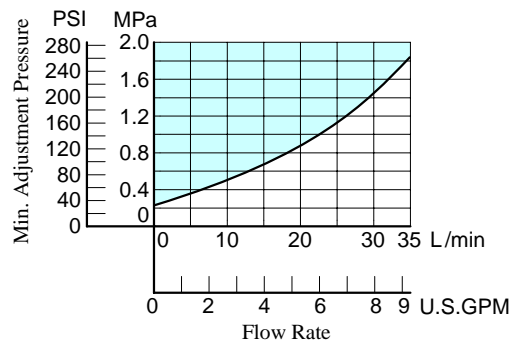

F

MRP-01-* -30/3090

MRA-01-* -30/3090

MRB-01-* -30/3090

**DIMENSIONS IN
MILLIMETRES (INCHES)**

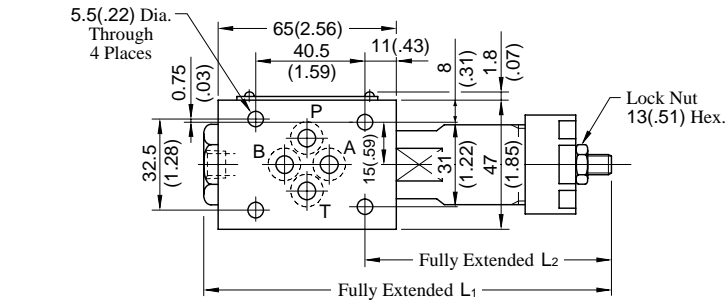

Model No.	L1	L2
MR*-01-B C	158 (6.22)	92 (3.62)
MR*-01-H	173.5 (6.83)	107.5 (4.23)

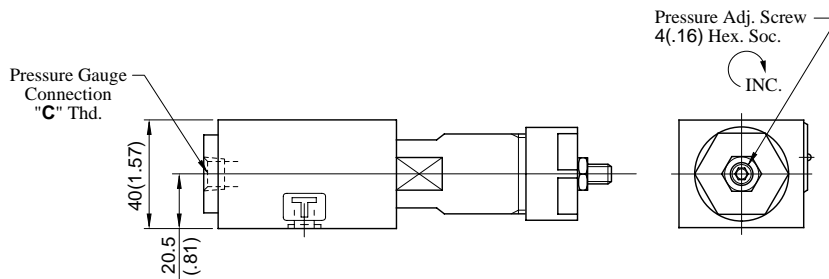

Model Numbers	Piping Size "C" Thd.
MR*-01-* -30	Rc 1/4 = 1/4 BSP.Tr
MR*-01-* -3090	1/4 NPT

Approx. Mass..... 1.1 kg (2.4 lbs.)

■ Spare Parts List

MRP-01-* -30/3090

MRA-01-* -30/3090

MRB-01-* -30/3090

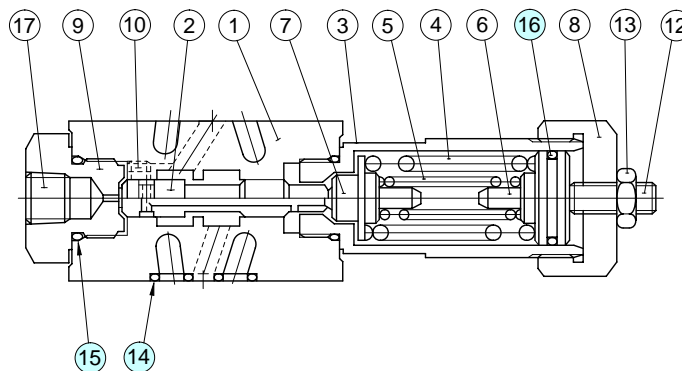

● List of Seals

Item	Name of Parts	Part Numbers	Qty.	Remarks
14	O-Ring	SO-NB-P9	4	Included in Seal Kit Kit No.: KS-MBP-01-30
15	O-Ring	SO-NB-P18	2	
16	O-Ring	SO-NA-P20	1	

⚠ CAUTION

When making replacement of seals, please do it carefully after reading through the relevant instructions in the Operator's Manual.

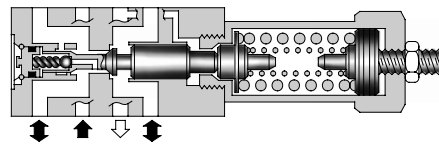

Specifications

Model Number	Max. Operating Pressure MPa (PSI)	Max. Flow L/min (U.S.GPM)
MBR-01-* -30/3090	25 (3630)	35 (9.25)

Model Number Designation

F-	MBR	-01	-C	-30	*
Special Seals	Series Number	Valve Size	Pres. Adj. Range MPa (PSI)	Design Number	Design Standard
F: Special Seals for Phosphate Ester Type Fluids (Omit if not required)	MBR: Brake Valve	01	C: *-14 ^{★1} (* -2030) H: 7-21 (1020-3050)	30	Refer to ★2

★1. See the "Minimum Adjustment Pressure" for the item marked *.

★2. Design Standards: None Japanese Standard "JIS" and European Design Standard 90 N. American Design Standard

Typical Performance Characteristics

Hydraulic Fluid: Viscosity 35 mm²/s (164 SSU), Specific Gravity 0.850

Graphic Symbol

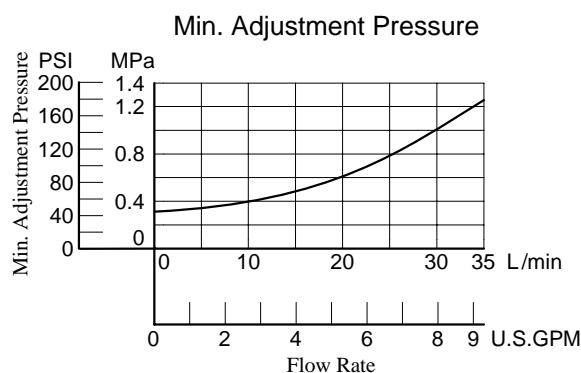
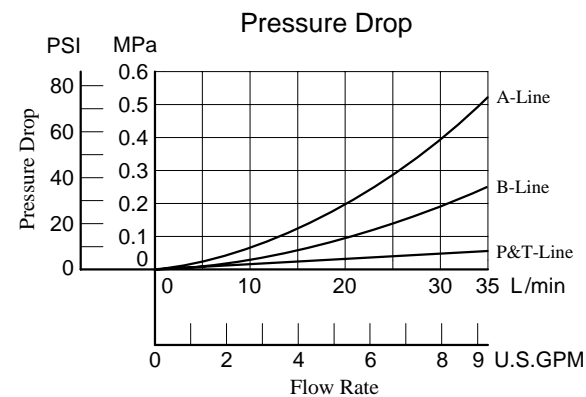
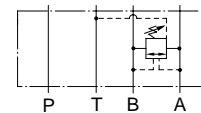

Instructions

- The minimum adjustment pressure equals the value obtained from the minimum adjustment pressure characteristics plus the tank line back pressure of the left. This back pressure should include the value of the T-line pressure drop characteristics of the valves stacked to the base plate side of the modular valve.
- To make pressure adjustment, loosen the lock nut and turn the pressure adjustment screw clockwise or anti-clockwise. For an increase of pressure, turn the screw clockwise. Be sure to re-tighten the lock nut firmly after making adjustment to the pressure.

MBR-01-* -30/3090

**DIMENSIONS IN
MILLIMETRES (INCHES)**

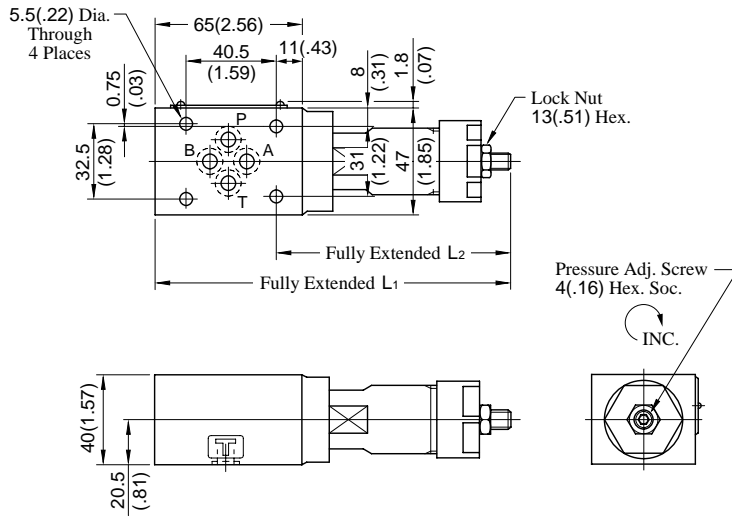

Model No.	L ₁	L ₂
MBR-01-C	161 (6.34)	107 (4.21)
MBR-01-H	176.5 (6.95)	122.5 (4.82)

Approx. Mass..... 1.3 kg (2.9 lbs.)

■ Spare Parts List

MBR-01-* -30/3090

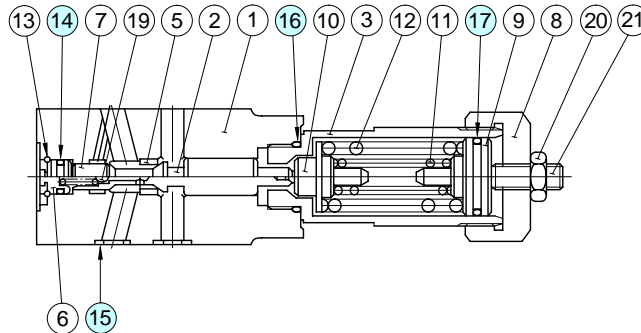

● List of Seals

Item	Name of Parts	Part Numbers	Qty.	Remarks
14	O-Ring	SO-NB-P7	1	Included in Seal Kit Kit No.: KS-MBR-01-30
15	O-Ring	SO-NB-P9	4	
16	O-Ring	SO-NB-P18	1	
17	O-Ring	SO-NA-P20	1	

⚠ CAUTION

When making replacement of seals, please do it carefully after reading through the relevant instructions in the Operator's Manual.

Specifications

Model Numbers	Max. Operating Pressure MPa (PSI)	Max. Flow L/min (U.S.GPM)	Free Flow L/min (U.S.GPM)
MHP-01-*-30/3090	25 (3630)	35 (9.25)	—
MHA-01-*-30/3090			35 (9.25)



Graphic Symbols

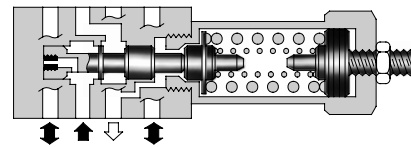
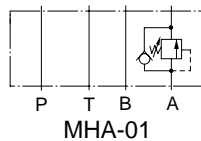
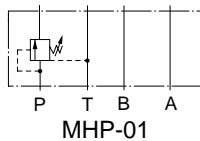

MHP-01

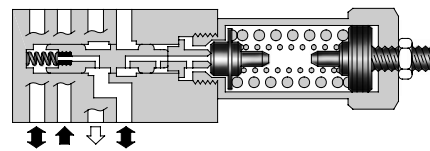

MHA-01

Model Number Designation

F-	MHP	-01	-C	-30	*
Special Seals	Series Number	Valve Size	Pres. Adj. Range MPa (PSI)	Design Number	Design Standard
F: Special Seals for Phosphate Ester Type Fluids (Omit if not required)	MHP: Sequence Valve for P-Line MHA: Counterbalance Valve for A-Line	01	C: *-14 * ¹ (*-2030) H: 7-21 (1020-3050)	30	Refer to ★2

★ 1. See the "Minimum Adjustment Pressure" of the next page for the item marked *.

★ 2. Design Standards: None Japanese Standard "JIS" and European Design Standard 90 N. American Design Standard

Instructions

- The minimum adjustment pressure (MHP-01) equals the value obtained from the minimum adjustment pressure characteristics plus the tank line back pressure of the next page. This back pressure should include the value of the T-line pressure drop characteristics of the valves stacked to the base plate side of the modular valve.
- To make pressure adjustment, loosen the lock nut and turn the pressure adjustment screw clockwise or anti-clockwise. For an increase of pressure, turn the screw clockwise. Be sure to re-tighten the lock nut firmly after making adjustment to the pressure.
- The minimum adjustment pressure (MHA-01) equals the value obtained from the minimum adjustment pressure characteristics plus the outlet-side back pressure of the valve on the next page. The outlet-side back pressure should include the values of the A-line and T-line pressure drop characteristics of the valves to be stacked due to the valve with internal drain.



Typical Performance Characteristics

Hydraulic Fluid: Viscosity 35 mm²/s (164 SSU), Specific Gravity 0.850

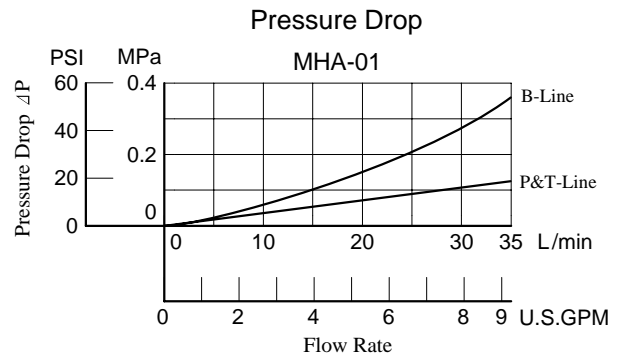
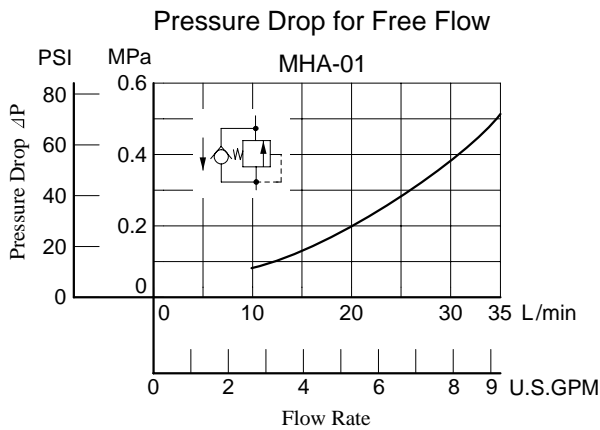
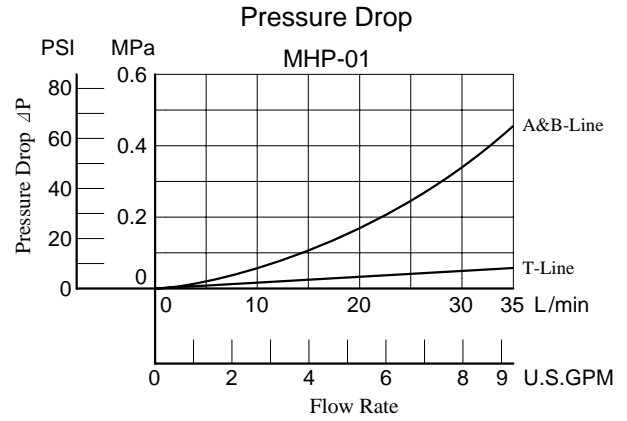
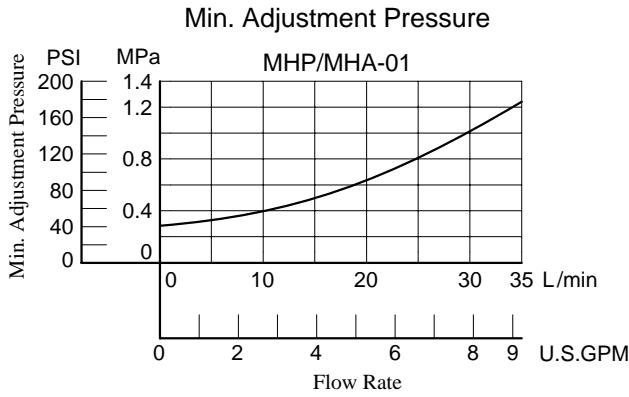

MHP-01-* -30/3090

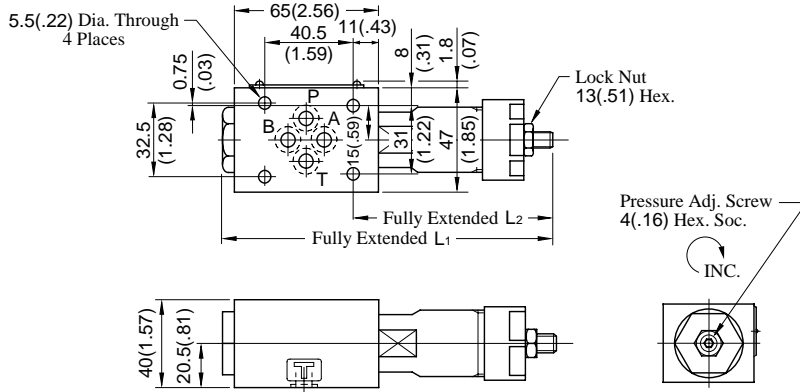

Model Numbers	L ₁	L ₂
MHP-01-C	151 (5.94)	92 (3.62)
MHP-01-H	166.5 (6.56)	107.5 (4.23)

Approx. Mass..... 1.1 kg (2.4 lbs.)

DIMENSIONS IN
MILLIMETRES (INCHES)

MHA-01-* -30/3090

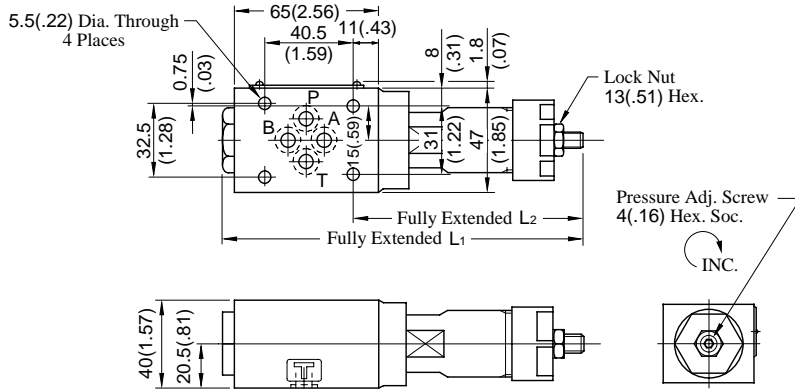

Model Numbers	L ₁	L ₂
MHA-01-C	171 (6.73)	112 (4.41)
MHA-01-H	186.5 (7.34)	127.5 (5.02)

Approx. Mass..... 1.3 kg (2.9 lbs.)

■ Spare Parts List

⚠ CAUTION

When making replacement of seals, please do it carefully after reading through the relevant instructions in the Operator's Manual.

MHP-01-* -30/3090

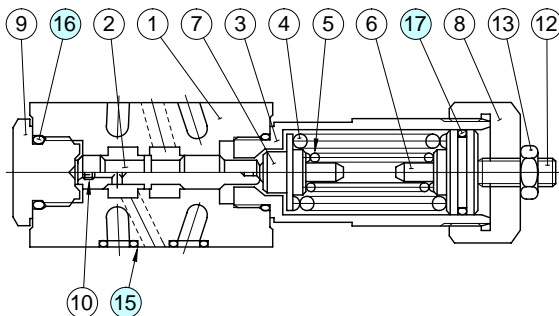

● List of Seals

Item	Name of Parts	Part Numbers	Qty.	Remarks
15	O-Ring	SO-NB-P9	4	Included in Seal Kit Kit No.: KS-MBP-01-30
16	O-Ring	SO-NB-P18	2	
17	O-Ring	SO-NA-P20	1	

MHA-01-* -30/3090

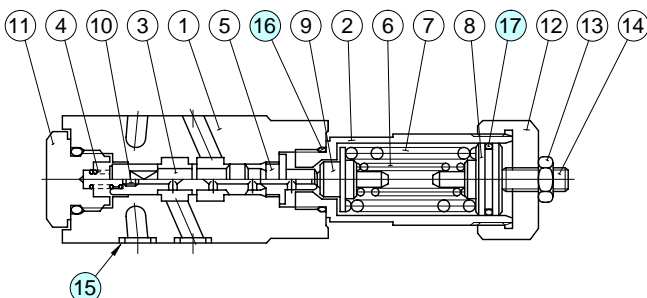

● List of Seals

Item	Name of Parts	Part Numbers	Qty.	Remarks
15	O-Ring	SO-NB-P9	4	Included in Seal Kit Kit No.: KS-MBP-01-30
16	O-Ring	SO-NB-P18	2	
17	O-Ring	SO-NA-P20	1	

1/8, Pressure Switches

For "P" Line: **MJP-01-M-*-*-10/1090**

For "A" Line: **MJA-01-M-*-*-10/1090**

For "B" Line: **MJB-01-M-*-*-10/1090**

Specifications / Model Number Designation

■ Specifications

Model Numbers	Max. Operating Pressure MPa(PSI)	Max. Flow L/min (U.S.GPM)
MJP-01-M-*-*-10/1090 MJA-01-M-*-*-10/1090 MJB-01-M-*-*-10/1090	31.5 (4570)	35 (9.25)



● Sensitive Switch Ratings

Electric Source	AC		DC	
	V	125 • 250	125	250
Current	A	11A-1/3HP	0.5	0.25

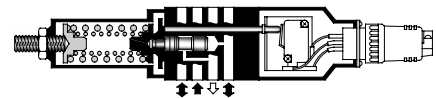

■ Model Number Designation

F-	MJP	-01	-M	-B	-N	-10	*
Special Seals	Series Number	Valve Size	Type of Switch	Pres. Adj. Range MPa (PSI)	Type of Electrical Connection	Design Number	Design Standard
F: Special Seals for Phosphate Ester Type Fluids (Omit if not required)	MJP : Pressure Switch for P-Line MJA : Pressure Switch for A-Line MJB : Pressure Switch for B-Line	01	M: Sensitive Switch	B: 1-7 (145-1020) C: 3.5-14 (510-2030) H: 7-21 (1020-3050)	None: Cable Connector Type N: With Plug-in Connector (DIN)	10	Refer to ★

★ Design Standards: None Japanese Standard "JIS" and European Design Standard
90 N. American Design Standard

Graphic Symbols

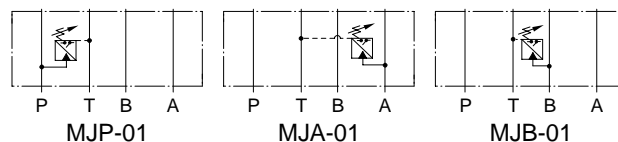

■ Instructions

- To make pressure adjustment, loosen the lock nut and turn the pressure adjustment screw clockwise or anti-clockwise. For an increase of pressure, turn the screw clockwise. Be sure to re-tighten the lock nut firmly after making adjustment to the pressure.
- Wiring of a sensitive switch should be made correctly referring to the table below. Numbers in the switch status column indicate wiring numbers in receptacles or contact numbers of connectors.

(Pressure with Sensitive Switch)
and The Switch Status

Operating Pressure	Switch Status
Less than Pressure setting	1 ○ 2 ○ 3
More than Pressure setting	1 ○ 2 ○ 3

■ Attachment

Valve Model No.	Attachment
MJ*-01-M-*-10/1090	Cable connector: NJC-203-PR 1 Pc.
MJ*-01-M-*-N-10/1090	DIN connector: GDM311-B-11... 1 Pc.

■ Pressure Drop

Hydraulic Fluid: Viscosity 35 mm²/s (164 SSU), Specific Gravity 0.850

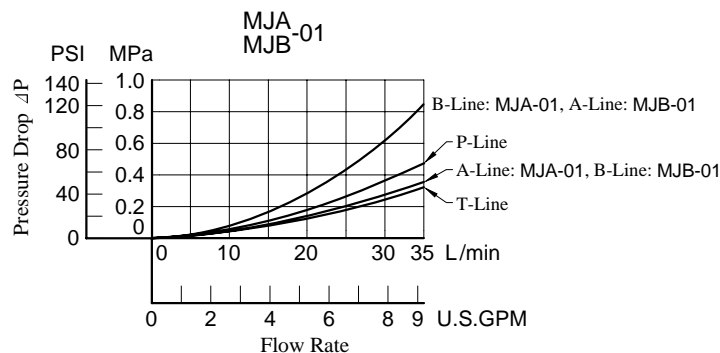
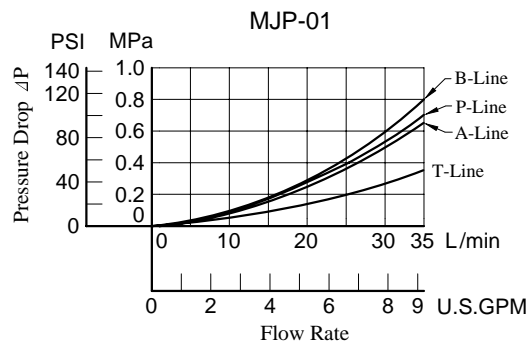

● Cable Connector Type

MJP-01-M-* -10/1090

MJA-01-M-* -10/1090

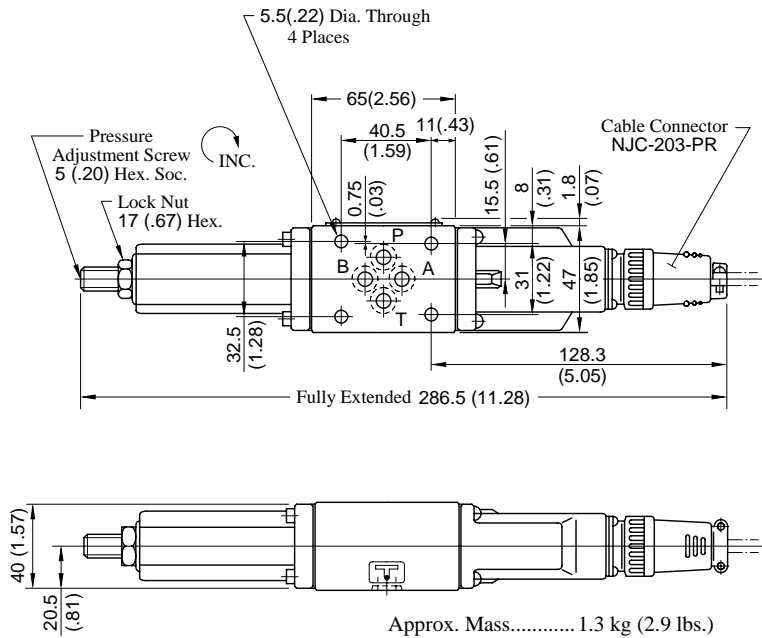

MJB-01-M-* -10/1090

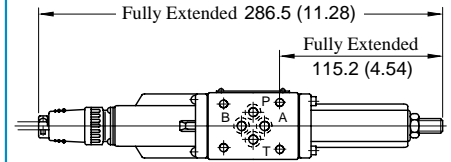

Approx. Mass..... 1.3 kg (2.9 lbs.)

- For other dimensions, refer to "MJ^P_A-01" drawing left.

DIMENSIONS IN MILLIMETRES (INCHES)

● Plug-in Connector Type

MJP-01-M-* -N-10/1090

MJA-01-M-* -N-10/1090

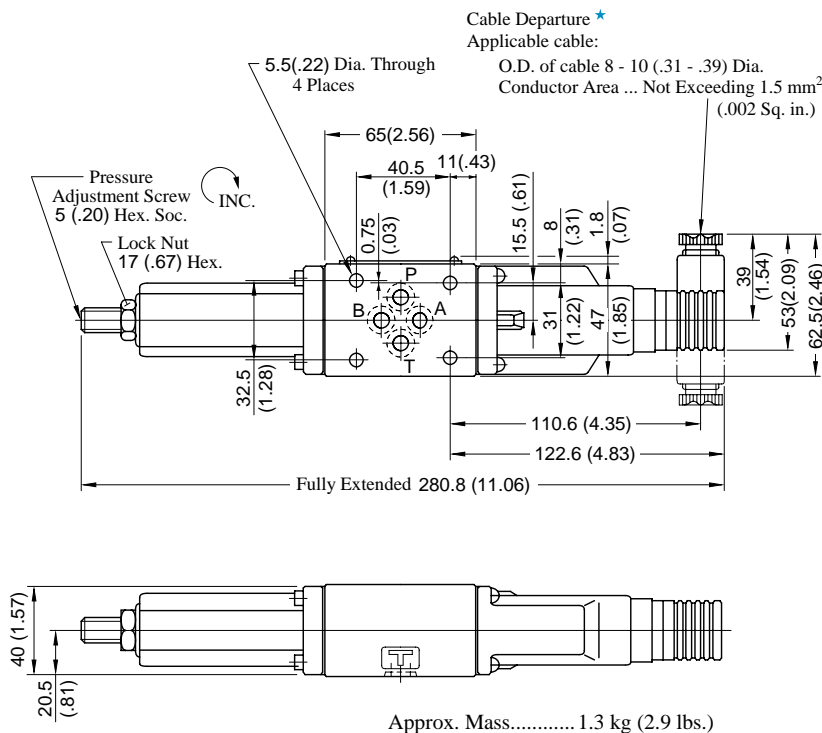

MJB-01-M-* -N-10/1090

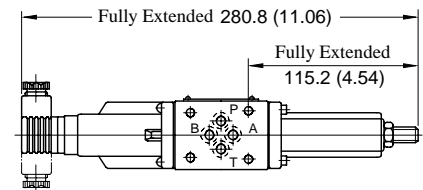

Approx. Mass..... 1.3 kg (2.9 lbs.)

- For other dimensions, refer to "MJ^P_A-01" drawing left.

★ As shown by the dot-and-dash line, the cable departure can also be faced opposite.

■ Spare Parts List

● Plug-in Connector Type

MJP-01
MJA-01-M-*-N-10/1090
MJB-01

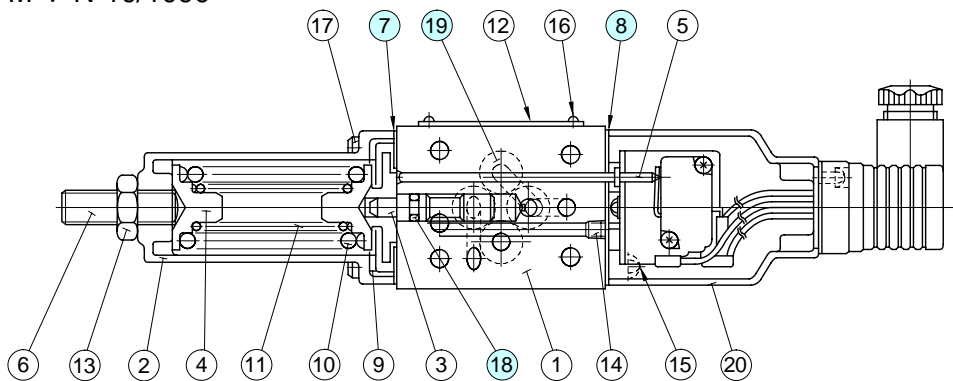

● Cable Connector Type

MJP
MJA-01-M-*-10/1090
MJB

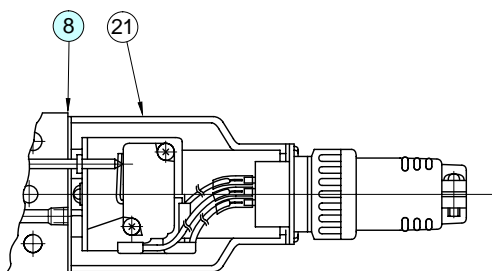

● List of Seals

Item	Name of Parts	Part Numbers	Qty.
7	Packing	3116-VK414239-4	1
8	Packing	3116-VK414240-2	1
18	O-Ring	SO-NA-P5	1
19	O-Ring	SO-NB-P9	4

Note: When ordering seals, please specify the seal kit number from the table below.

● List of Seal Kits

Model No.	Seal Kit Numbers
MJP-01	Included in seal kit Kit No.: KS-MJP-01-10
MJA-01	
MJB-01	

⚠ CAUTION

When making replacement of seals, please do it carefully after reading through the relevant instructions in the Operator's Manual.

F

Specifications / Others

Specifications

Model Numbers	Max. Operating Pressure MPa (PSI)	Max. Metred Flow L/min (U.S.GPM)	Max. Free Flow L/min (U.S.GPM)
MFP-01-10/1090	16 (2320)	35 (9.25)	—
MFA-01-*-10/1090			35 (9.25)
MFB-01-*-10/1090			
MFW-01-*-10/1090			

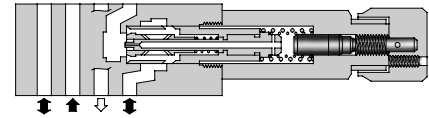

Model Number Designation

F-	MFA	-01	-X	-10	*
Special Seals	Series Number	Valve Size	Direction of Flow	Design Number	Design Standard
F: Special Seals for Phosphate Ester Type Fluids (Omit if not required)	MFP : Flow Control Valve for P-Line	01	—	10	Refer to ★
	MFA : Flow Control and Check Valve for A-Line MFB : Flow Control and Check Valve for B-Line MFW : Flow Control and Check Valve for A&B-Lines		X : Metre-out Y : Metre-in	10	

★ Design Standards: None Japanese Standard "JIS" and European Design Standard
 90 N. American Design Standard

Graphic Symbols

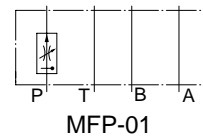

Instructions

- To make flow rate adjustment, loosen locking screw for the dial and turn the flow adjustment dial clockwise or anti-clockwise. For a decrease of flow, turn the dial clockwise. Be sure to retighten the locking screw firmly after the adjustment of the flow rate.

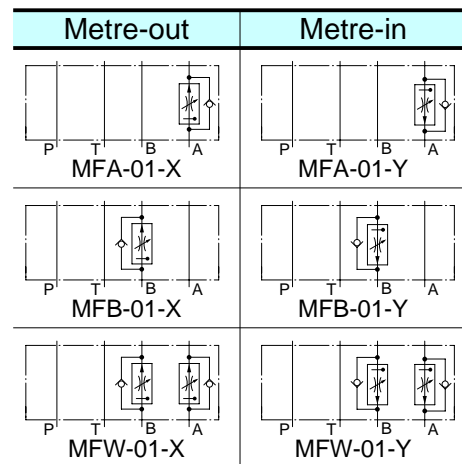

Typical Performance Characteristics

Hydraulic Fluid: Viscosity 35 mm²/s (164 SSU), Specific Gravity 0.850

Min. Required Pressure Difference

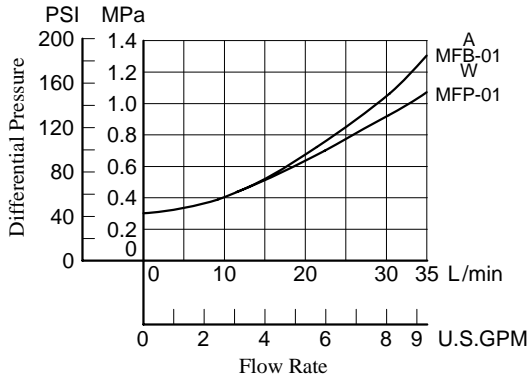

Metred Flows vs. Dial Position

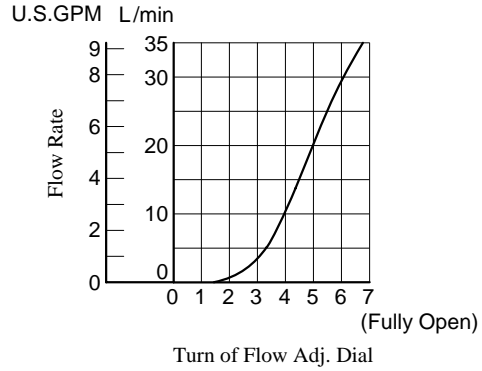

Min. Metred Flow

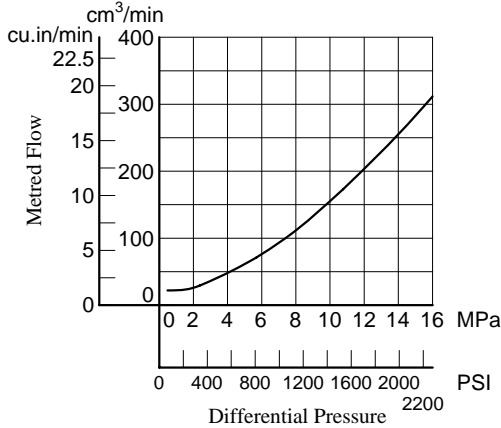

Metred Flow vs. Viscosity

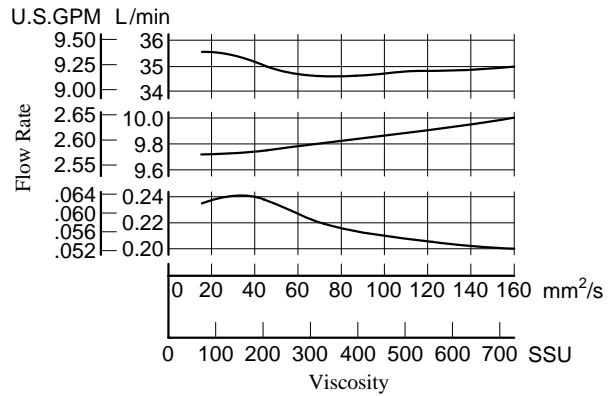

Pressure Drop

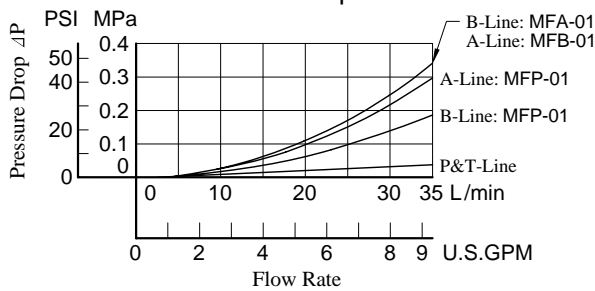

Metred Flow vs. Differential Pres.

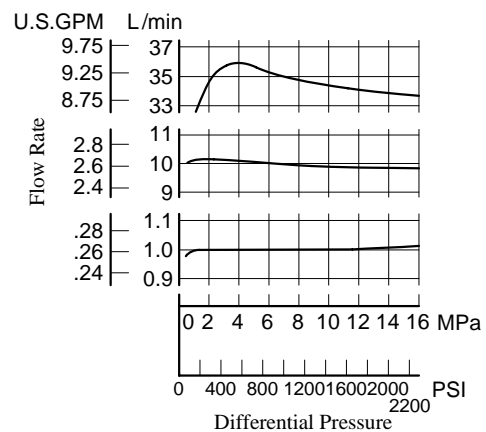

Pressure Drop for Free Flow

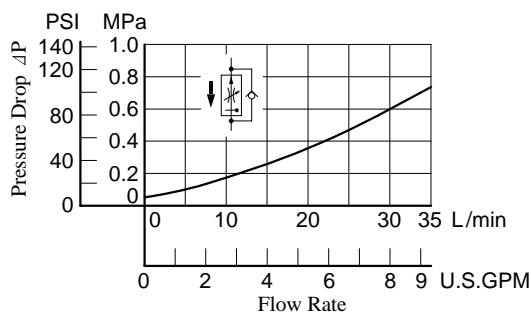

Installation Drawing

MFP-01-10/1090

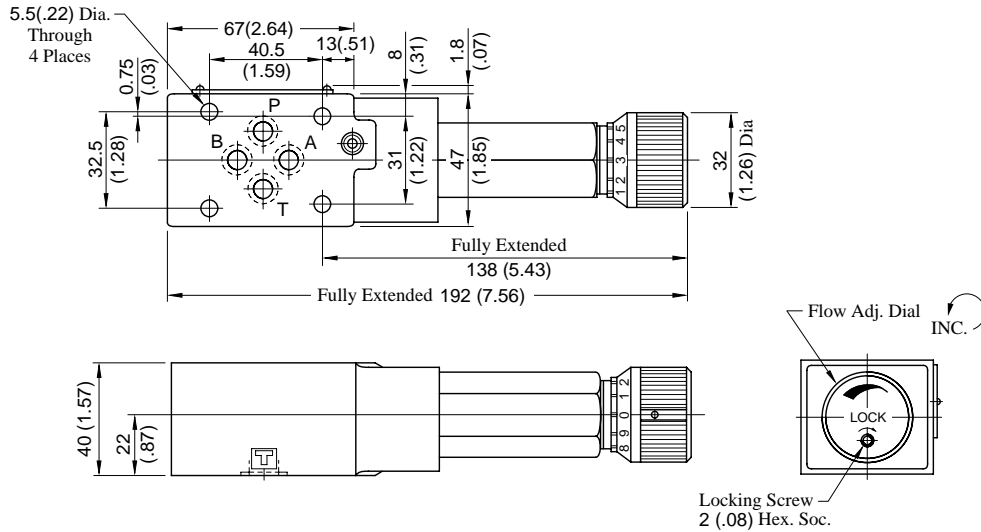

Approx. Mass..... 1.7 kg (3.8 lbs.)

MFW-01-X-Y-10/1090

DIMENSIONS IN
MILLIMETRES (INCHES)

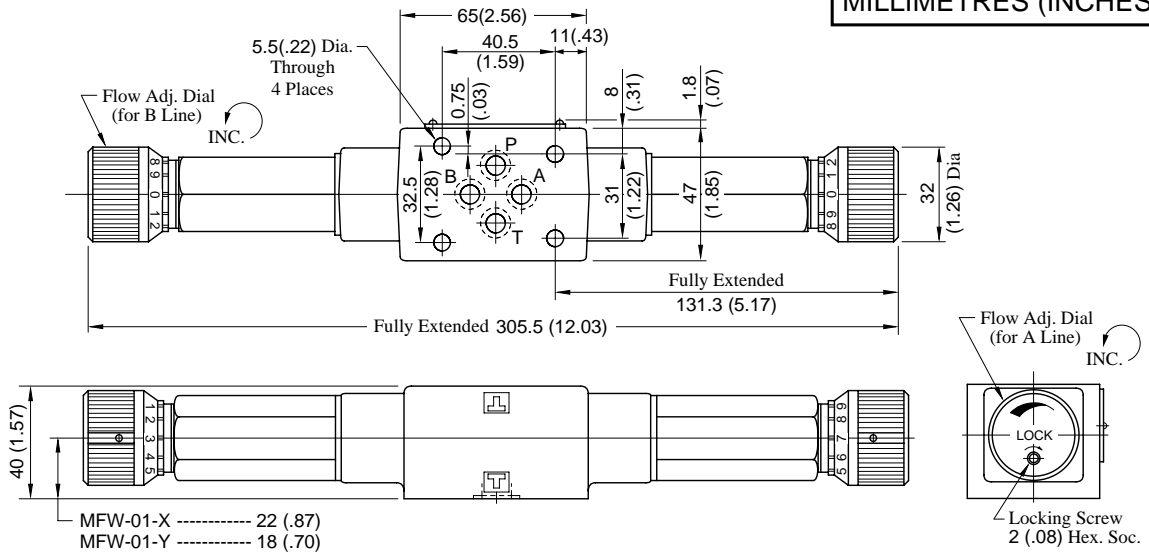

Approx. Mass..... 2.1 kg (4.6 lbs.)

MFA-01-X-Y-10/1090

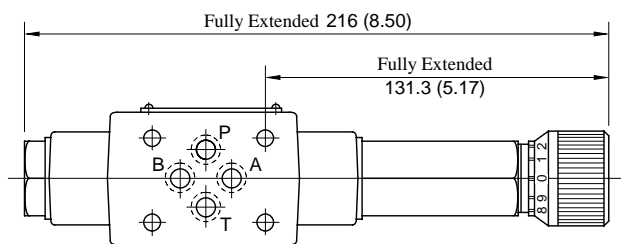

Approx. Mass..... 1.6 kg (3.5 lbs.)

MFB-01-X-Y-10/1090

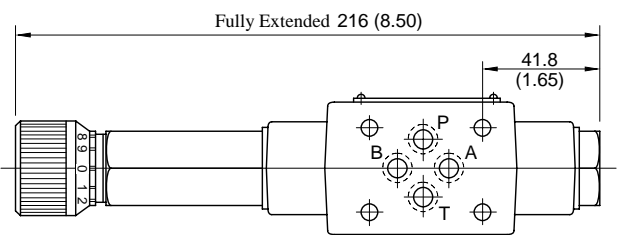

Approx. Mass..... 1.6 kg (3.5 lbs.)

• For other dimensions, refer to "MFW-01" drawing above.

Spare Parts List

■ Spare Parts List

MFP-01-10/1090

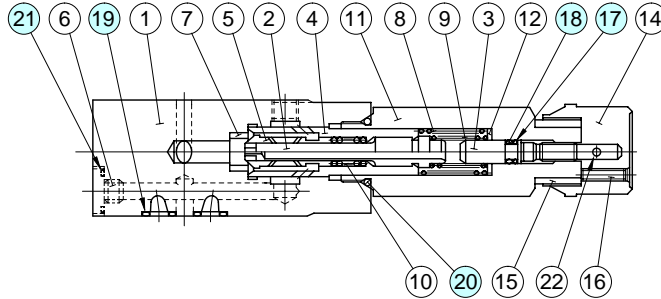

MFW-01-X_Y-10/1090

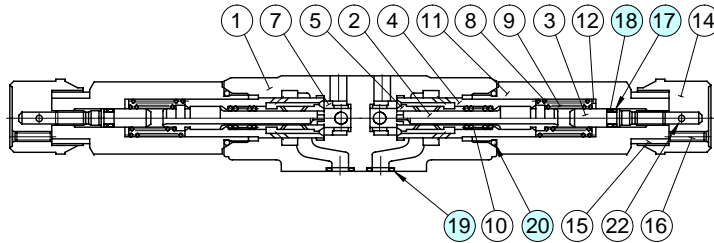

MFA-01-X_Y-10/1090

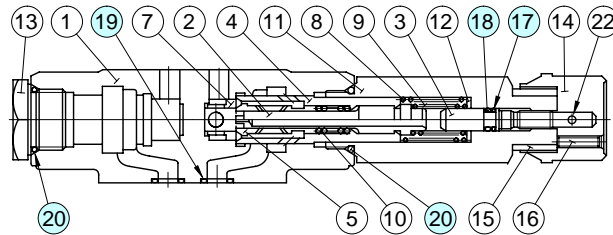

MFB-01-X_Y-10/1090

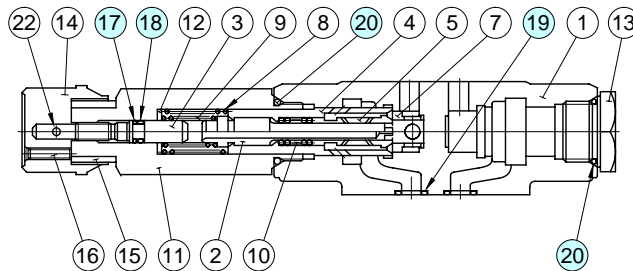

● List of Seals

Item	Name of Parts	Part Numbers	Quantity			
			MFP-01	MFA-01	MFB-01	MFW-01
17	Back Up Ring	SO-BB-P6	1	1	1	2
18	O-Ring	SO-NA-P6	1	1	1	2
19	O-Ring	SO-NB-P9	4	4	4	4
20	O-Ring	SO-NB-P18	1	2	2	2
21	O-Ring	SO-NB-P10	1	—	—	—

● List of Seal Kits

Model Numbers	Seal Kit Numbers
MFP-01	KS-MFP-01-10
MFA-01	KS-MFA-01-10
MFB-01	
MFW-01	KS-MFW-01-10

Note: When ordering seals, please specify the seal kit number from the table right.



CAUTION

When making replacement of seals, please do it carefully after reading through the relevant instructions in the Operator's Manual.

F

Specifications / Others

Specifications

Model Numbers	Max. Operating Pressure	Max. Differential Pressure	Max. Metred Flow	Min. Metred Flow	Max. Free Flow
	MPa (PSI)	MPa (PSI)	L/min (U.S.GPM)	L/min (U.S.GPM)	L/min (U.S.GPM)
MSTA-01-X-10/1090 MSTB-01-X-10/1090 MSTW-01-X-10/1090	31.5 (4570)	14 (2030)	35 (9.25)	0.5 (0.13)	35 (9.25)

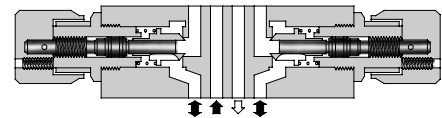

Model Number Designation

F-	MSTA	-01	-X	-10	*
Special Seals	Series Number	Valve Size	Direction of Flow	Design Number	Design Standard
F: Special Seals for Phosphate Ester Type Fluids (Omit if not required)	MSTA : Temperature Compensated Throttle and Check Valve for A-Line MSTB : Temperature Compensated Throttle and Check Valve for B-Line MSTW : Temperature Compensated Throttle and Check Valve for A&B-Lines	01	X : Metre-out	10	Refer to ★

★ Design Standards: None Japanese Standard "JIS" and European Design Standard 90 N. American Design Standard

Instructions

- To make flow rate adjustment, loosen locking screw for the dial and turn the flow adjustment dial clockwise or anti-clockwise. For a decrease of flow, turn the dial clockwise. Be sure to re-tighten the locking screw firmly after the adjustment of the flow rate.

Graphic Symbols

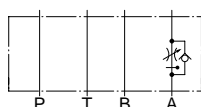

MSTA-01-X

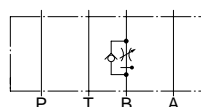

MSTB-01-X

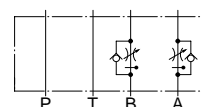

MSTW-01-X

Typical Performance Characteristics

Hydraulic Fluid: Viscosity 35 mm²/s (164 SSU), Specific Gravity 0.850

Pressure Drop

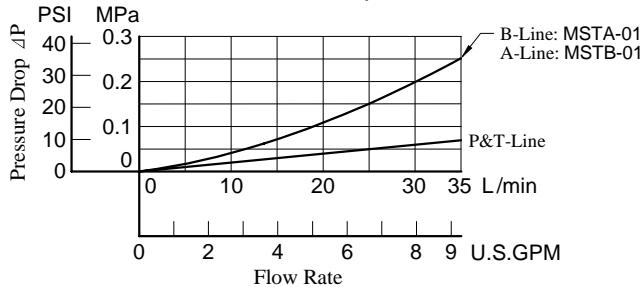

Pressure Drop at Throttle Fully Open

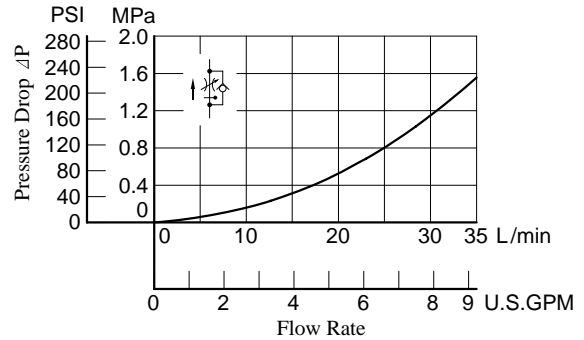

Pressure Drop for Free Flow

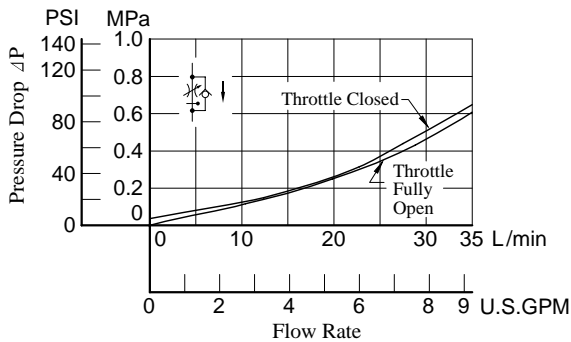

Metred Flow vs. Viscosity

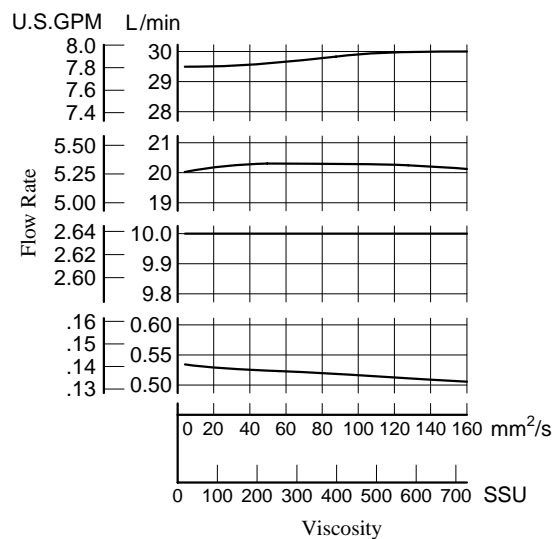

Metred Flow vs. Dial Position

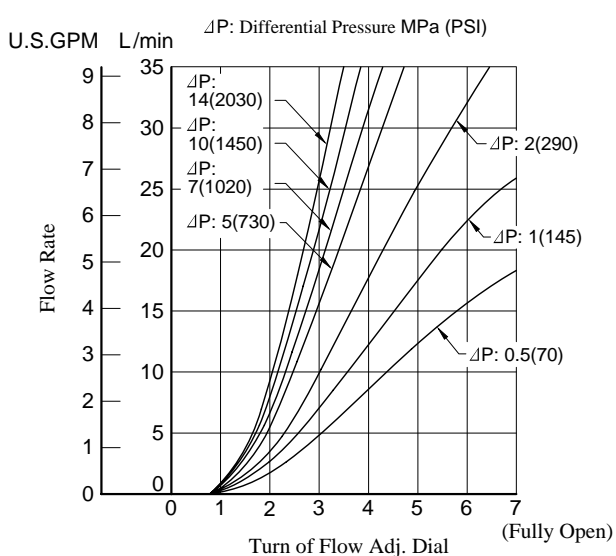

MSTW-01-X-10/1090

**DIMENSIONS IN
MILLIMETRES (INCHES)**

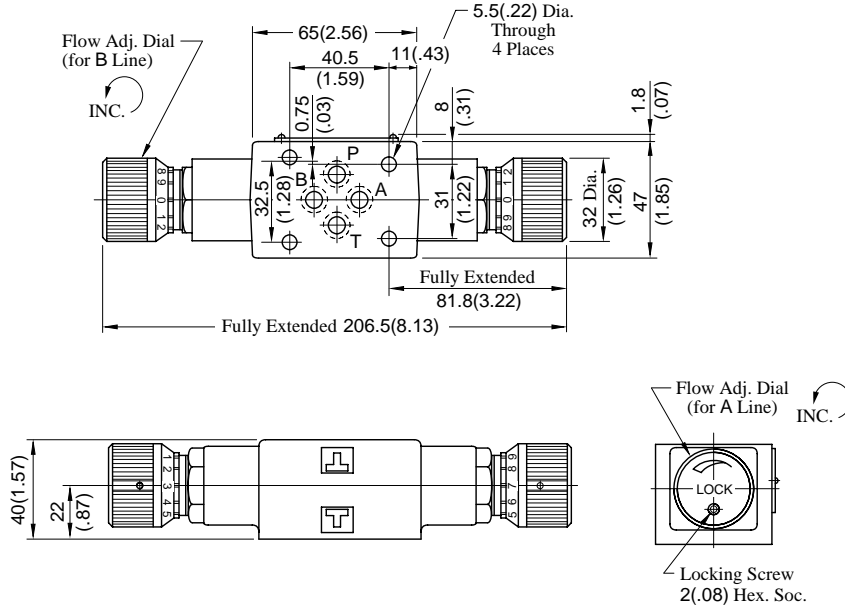

Approx. Mass..... 1.5 kg (3.3 lbs.)

MSTA-01-X-10/1090

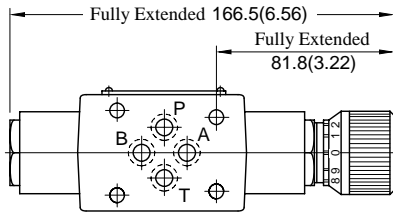

Approx. Mass..... 1.3 kg (2.9 lbs.)

MSTB-01-X-10/1090

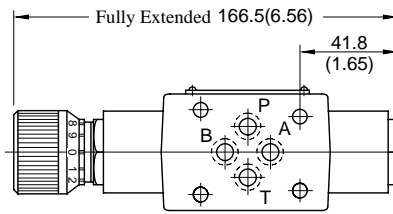

Approx. Mass..... 1.3 kg (2.9 lbs.)

• For other dimensions, refer to "MSTW-01" drawing above.

Spare Parts List

■ Spare Parts List

MSTA-01-X-10/1090

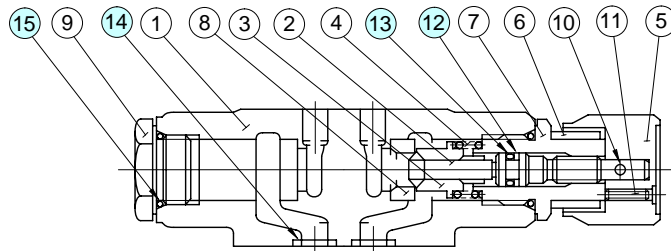

MSTB-01-X-10/1090

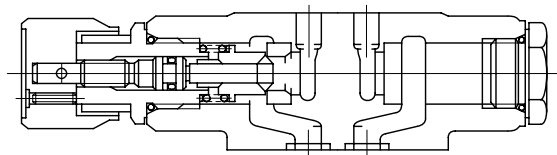

MSTW-01-X-10/1090

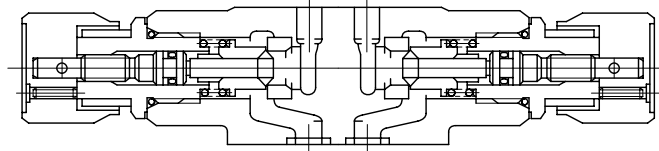

● List of Seals

Item	Name of Parts	Part Numbers	Quantity		
			MSTA	MSTB	MSTW
12	Back Up Ring	SO-BB-P6	1	1	2
13	O-Ring	SO-NA-P6	1	1	2
14	O-Ring	SO-NB-P9	4	4	4
15	O-Ring	SO-NB-P18	2	2	2

● List of Seal Kits

Model Numbers	Seal Kit Numbers
MSTA-01	KS-MFA-01-10
MSTB-01	
MSTW-01	KS-MFW-01-10

Note: When ordering seals, please specify the seal kit number from the table right.

⚠ CAUTION

When making replacement of seals, please do it carefully after reading through the relevant instructions in the Operator's Manual.

F

Specifications

Model Number	Max. Operating Pressure MPa (PSI)	Max. Flow L/min (U.S.GPM)
MSP-01-50/5090	31.5 (4570)	35 (9.25) *

★ At the low differential pressure, maximum flow is limited. See "Pressure Drop at Throttle Fully Open".



Model Number Designation

F-	MSP	-01	-50	*
Special Seals	Series Number	Valve Size	Design Number	Design Standard
F: Special Seals for Phosphate Ester Type Fluids (Omit if not required)	MSP: Throttle Valve for P-Line	01	50	Refer to ★

★ Design Standards: None Japanese Standard "JIS" and European Design Standard
90 N. American Design Standard

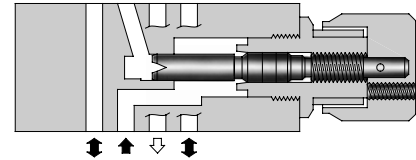

Graphic Symbol

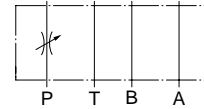

Typical Performance Characteristics

Hydraulic Fluid: Viscosity 35 mm²/s (164 SSU), Specific Gravity 0.850

Pressure Drop at Throttle Fully Open

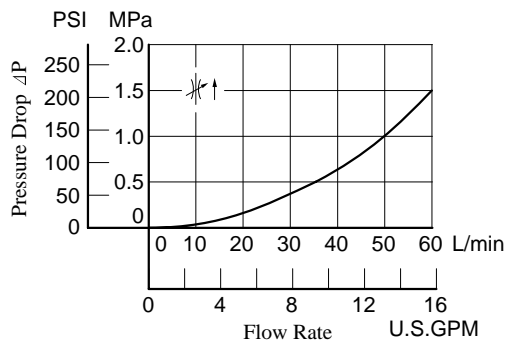

Pressure Drop

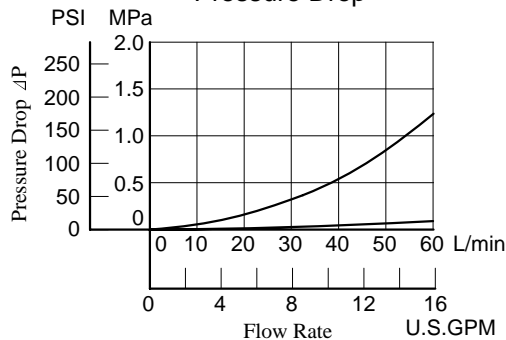

Metred Flow vs. Dial Position

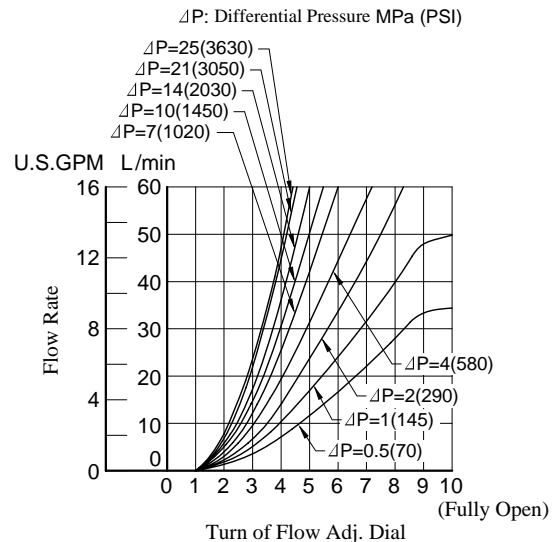

Instructions

- To make flow rate adjustment, loosen locking screw for the dial and turn the flow adjustment dial clockwise or anti-clockwise. For a decrease of flow, turn the dial clockwise. Be sure to re-tighten the locking screw firmly after the adjustment of the flow rate.

MSP-01-50/5090

DIMENSIONS IN
MILLIMETRES (INCHES)

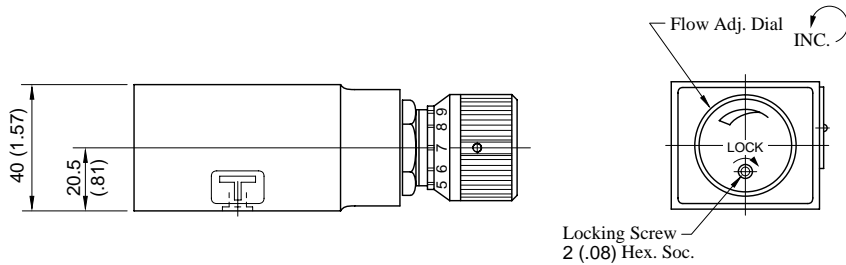
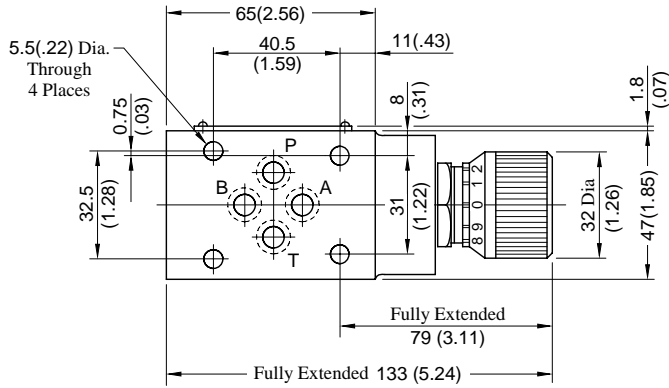

Approx. Mass..... 1.2 kg (2.6 lbs.)

■ Spare Parts List

MSP-01-50/5090

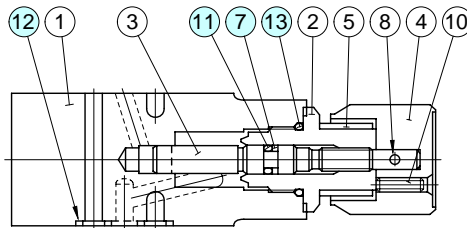

● List of Seals

Item	Name of Parts	Part Numbers	Qty.	Remarks
7	Back Up Ring	SO-BB-P6	1	Included in Seal Kit Kit No.: KS-MSP-01-50
11	O-Ring	SO-NA-P6	1	
12	O-Ring	SO-NB-P9	4	
13	O-Ring	SO-NB-P18	1	

⚠ CAUTION

When making replacement of seals, please do it carefully after reading through the relevant instructions in the Operator's Manual.

F

Specifications

Model Number	Max. Operating Pressure MPa (PSI)	Max. Flow L/min (U.S.GPM)
MSCP-01-30/3090	31.5 (4570)	35 (9.25) *

★ At the low differential pressure, maximum flow is limited. See "Pressure Drop at Throttle Fully Open".



Model Number Designation

F-	MSCP	-01	-30	*
Special Seals	Series Number	Valve Size	Design Number	Design Standard
F: Special Seals for Phosphate Ester Type Fluids (Omit if not required)	MSCP : Check and Throttle Valve for P-Line	01	30	Refer to ★

★ Design Standards: None Japanese Standard "JIS" and European Design Standard
90 N. American Design Standard

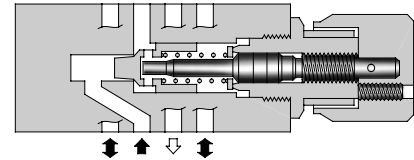

Graphic Symbol

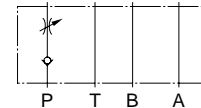

Typical Performance Characteristics

Hydraulic Fluid: Viscosity 35 mm²/s (164 SSU), Specific Gravity 0.850

Pressure Drop at Throttle Fully Open

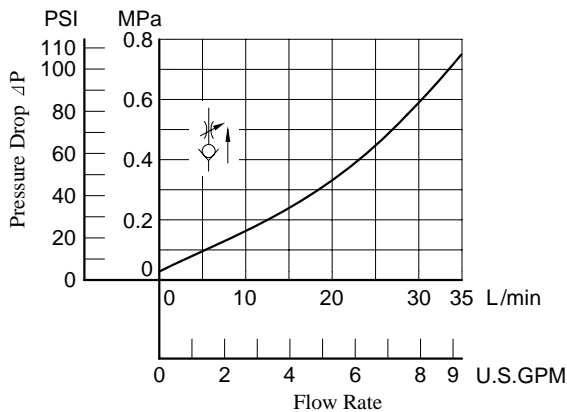

Metred Flow vs. Dial Position

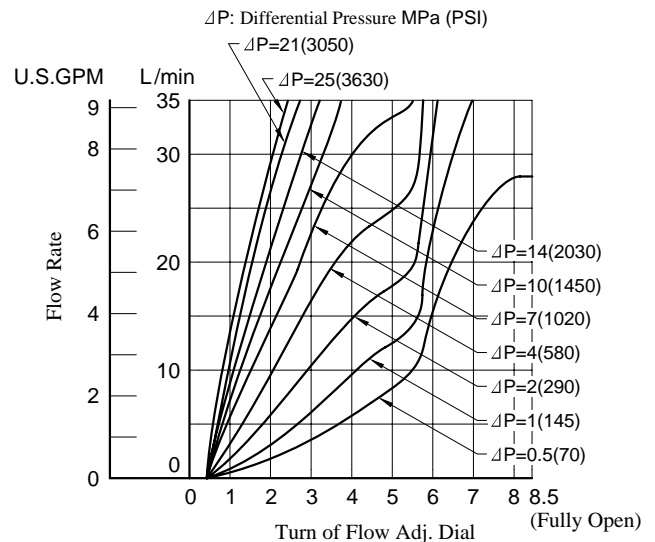

Pressure Drop

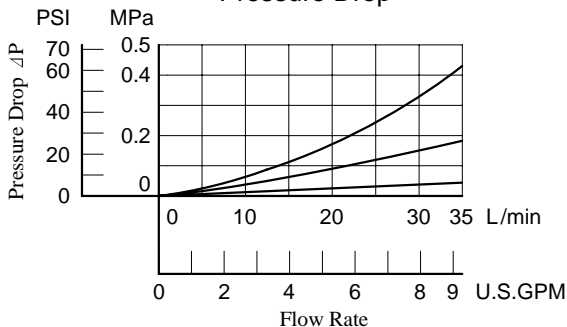

Instructions

- To make flow rate adjustment, loosen locking screw for the dial and turn the flow adjustment dial clockwise or anti-clockwise. For a decrease of flow, turn the dial clockwise. Be sure to re-tighten the locking screw firmly after the adjustment of the flow rate.

MSCP-01-30/3090

DIMENSIONS IN
MILLIMETRES (INCHES)

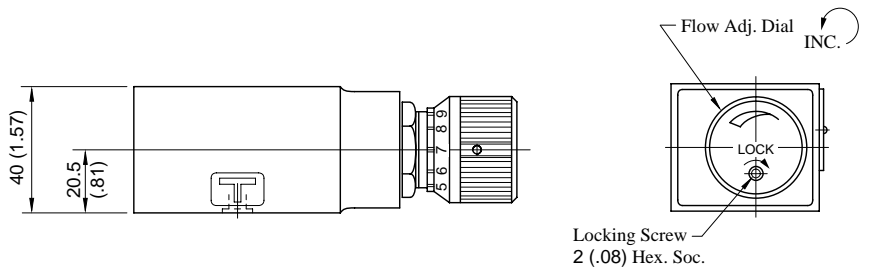
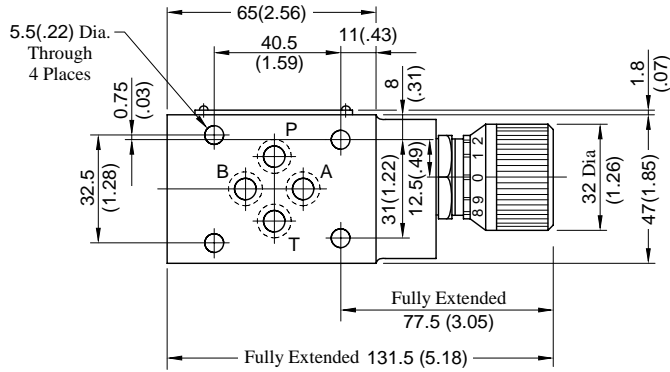

Approx. Mass..... 1.2 kg (2.6 lbs.)

■ Spare Parts List

MSCP-01-30/3090

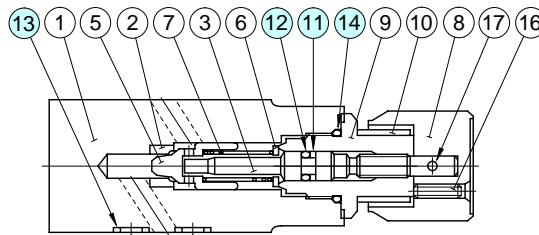

● List of Seals

Item	Name of Parts	Part Numbers	Qty.	Remarks
11	Back Up Ring	SO-BB-P6	1	Included in Seal Kit Kit No.: KS-MSP-01-30
12	O-Ring	SO-NA-P6	1	
13	O-Ring	SO-NB-P9	4	
14	O-Ring	SO-NB-P18	1	

⚠ CAUTION

When making replacement of seals, please do it carefully after reading through the relevant instructions in the Operator's Manual.

F

Specifications / Others

Specifications

Model Numbers	Max. Operating Pressure MPa (PSI)	Max. Flow L/min (U.S.GPM)
MSA-01-*-50/5090 MSB-01-*-50/5090 MSW-01-*-50/5090	31.5 (4570)	60 (15.9)★

★ At the low differential pressure, maximum flow is limited. See "Pressure Drop at Throttle Fully Open" of the next page.

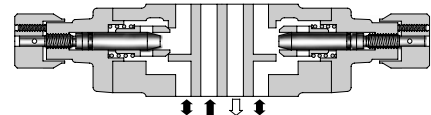

Model Number Designation

F-	MSW	-01	-X	Y	-50	*
Special Seals	Series Number	Valve Size	Direction of Flow ("A" Line)	Direction of Flow ("B" Line)	Design Number	Design Standard
F: Special Seals for Phosphate Ester Type Fluids (Omit if not required)	MSA : Throttle and Check Valve for A-Line	01	X : Metre-out Y : Metre-in	—	50	Refer to ★
	MSB : Throttle and Check Valve for B-Line		—	X : Metre-out Y : Metre-in		
	MSW : Throttle and Check Valve for A&B-Lines		X : Metre-out Y : Metre-in	X : Metre-out Y : Metre-in		
			X : Metre-out Y : Metre-in	X : Metre-out		

★ Design Standards: None Japanese Standard "JIS" and European Design Standard 90 N. American Design Standard

Graphic Symbols

Instructions

- To make flow rate adjustment, loosen locking screw for the dial and turn the flow adjustment dial clockwise or anti-clockwise. For a decrease of flow, turn the dial clockwise. Be sure to re-tighten the locking screw firmly after the adjustment of the flow rate.

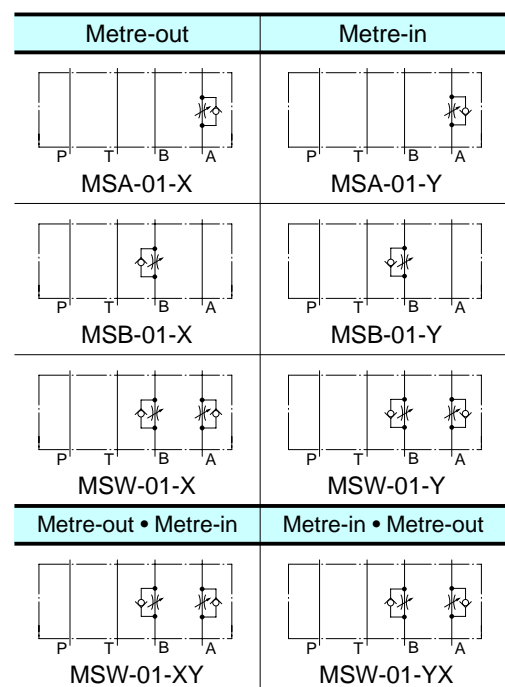

Typical Performance Characteristics

Hydraulic Fluid: Viscosity 35 mm²/s (164 SSU), Specific Gravity 0.850

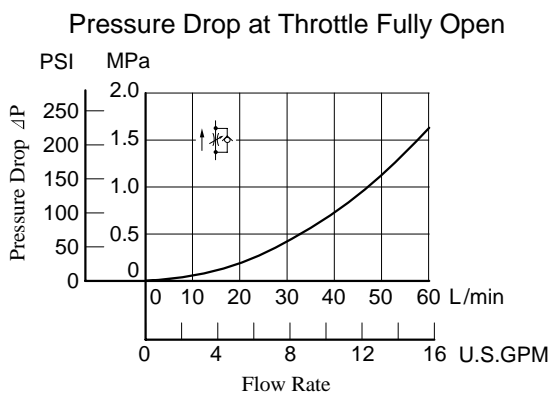
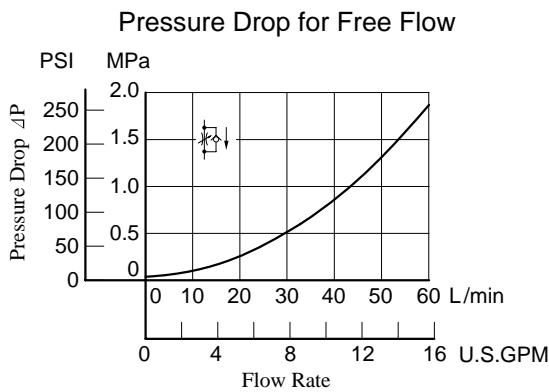
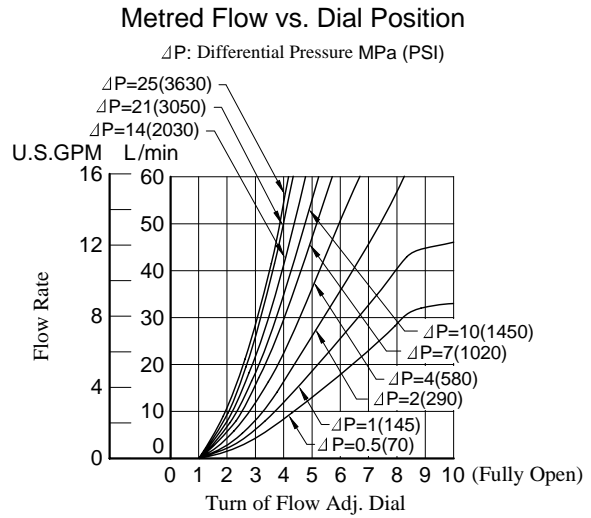
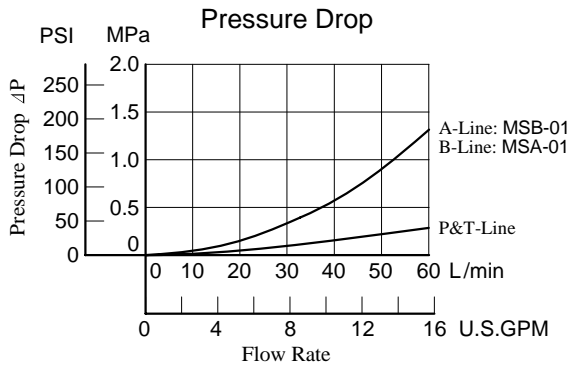

Application

● Circuit of Clamp Cylinder for Injection Molding Machine

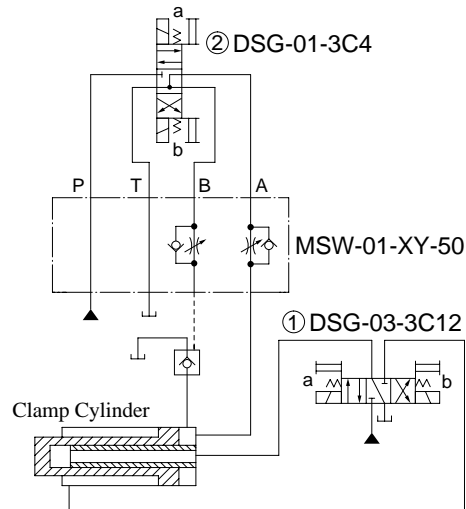

● Operation Sequence

Clamp Cylinder	Advance	End Point Pressurisation	Decompression	Retreat
Solenoid Operated Directional Valve ①	Sol.a ON	→	Centre Position	Sol.b ON
Solenoid Operated Directional Valve ②	Sol.b ON	Sol.a ON	Sol.b ON	→

MSW-01-X_Y-50/5090

DIMENSIONS IN
MILLIMETRES (INCHES)

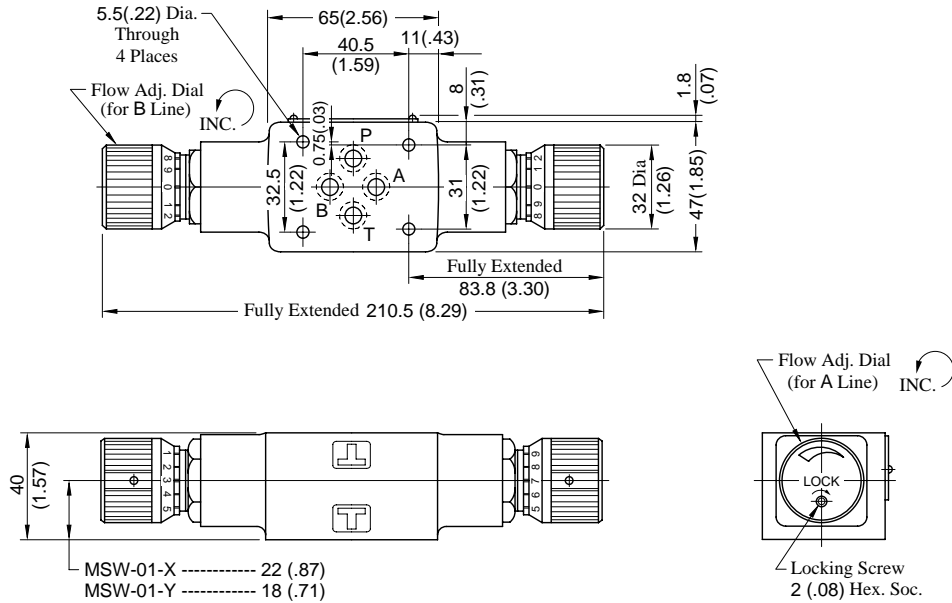

Approx. Mass..... 1.5 kg (3.3 lbs.)

MSW-01-XY_{YX}-50/5090

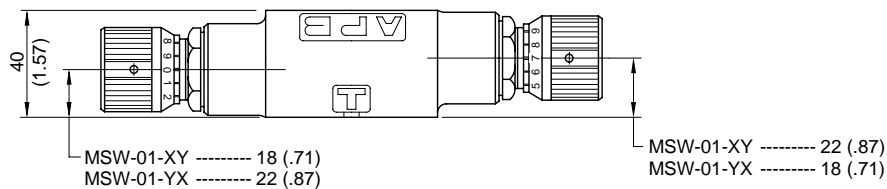

Approx. Mass..... 1.5 kg (3.3 lbs.)

• For other dimensions, refer to "MSW-01-X_Y" drawing above.

MSA-01-X_Y-50/5090

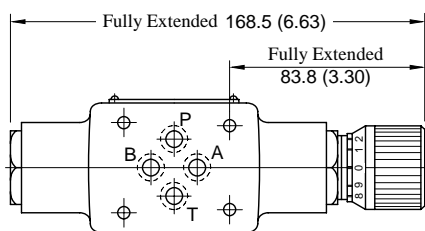

Approx. Mass..... 1.3 kg (2.9 lbs.)

MSB-01-X_Y-50/5090

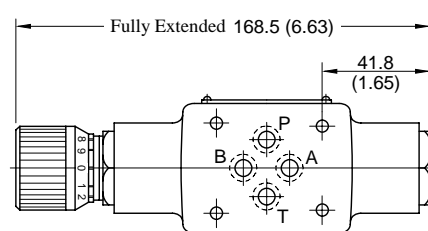

Approx. Mass..... 1.3 kg (2.9 lbs.)

• For other dimensions, refer to "MSW-01" drawing above.

■ Spare Parts List

MSA-01-X-50/5090

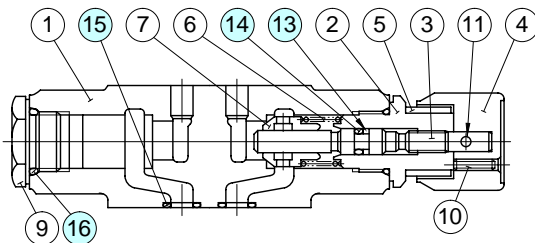

MSB-01-X-50/5090

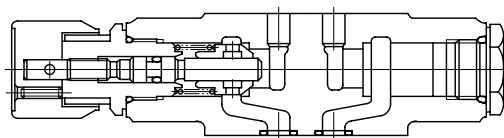

MSW-01-**-50/5090

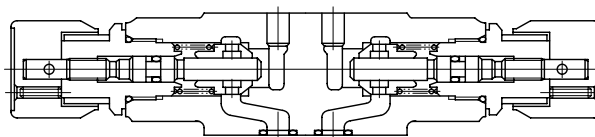

F

● List of Seals

Item	Name of Parts	Part Numbers	Quantity	
			MSA,MSB	MSW
13	Back Up Ring	SO-BB-P6	1	2
14	O-Ring	SO-NA-P6	1	2
15	O-Ring	SO-NB-P9	4	4
16	O-Ring	SO-NB-P18	2	2

● List of Seal Kits

Model Numbers	Seal Kit Numbers
MSA-01	KS-MSA-01-30
MSB-01	
MSW-01	KS-MSW-01-30

Note: When ordering seals, please specify the seal kit number from the table right.

⚠ CAUTION

When making replacement of seals, please do it carefully after reading through the relevant instructions in the Operator's Manual.

Specifications

Model Numbers	Max. Operating Pressure MPa (PSI)	Max. Flow L/min (U.S.GPM)
MCP-01-* -30/3090 MCT-01-* -30/3090	31.5 (4570)	35 (9.25)



Model Number Designation

F-	MCP	-01	-0	-30	*
Special Seals	Series Number	Valve Size	Cracking Pressure MPa (PSI)	Design Number	Design Standard
F: Special Seals for Phosphate Ester Type Fluids (Omit if not required)	MCP: Check Valve for P-Line MCT: Check Valve for T-Line	01	0: 0.035 (5) 2: 0.2 (29) 4: 0.4 (58)	30	Refer to ★

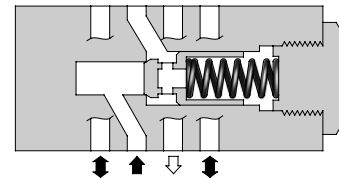

Graphic Symbols

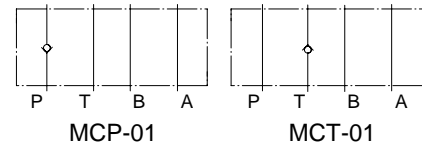

★ Design Standards: None Japanese Standard "JIS" and European Design Standard
90 N. American Design Standard

Typical Performance Characteristics

Hydraulic Fluid: Viscosity 35 mm²/s (164 SSU),
Specific Gravity 0.850

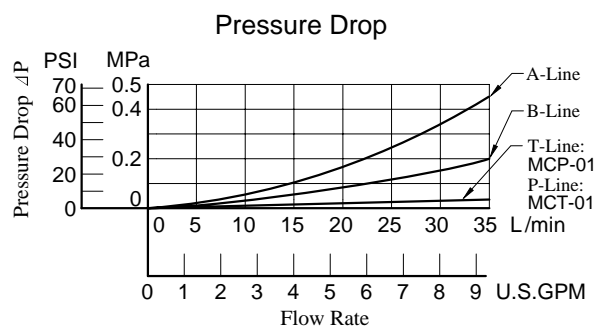
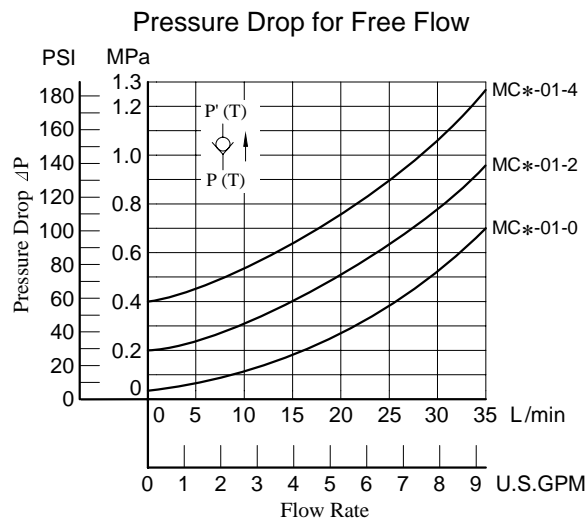

MCP-01-* -30/3090 MCT-01-* -30/3090

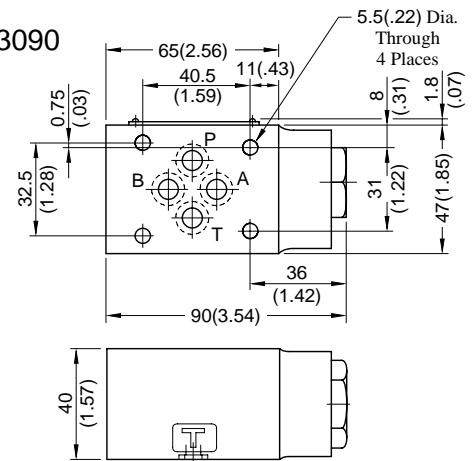

DIMENSIONS IN MILLIMETRES (INCHES)

Approx. Mass..... 1.1 kg (2.4 lbs.)

MCP-01-* -30/3090 MCT-01-* -30/3090

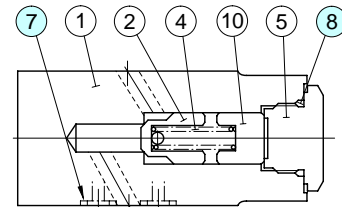

List of Seals

Item	Name of Parts	Part Numbers	Qty.	Remarks
7	O-Ring	SO-NB-P9	4	Included in Seal Kit
8	O-Ring	SO-NB-P18	1	Kit No.: KS-MCP-01-30

CAUTION

When making replacement of seals, please do it carefully after reading through the relevant instructions in the Operator's Manual.

Specifications

Model Number	Max. Operating Pressure MPa (PSI)	Max. Flow L/min (U.S.GPM)
MAC-01-30/3090	31.5 (4570)	35 (9.25)



Model Number Designation

F-	MAC	-01	-30	*
Special Seals	Series Number	Valve Size	Design Number	Design Standard
F: Special Seals for Phosphate Ester Type Fluids (Omit if not required)	MAC: Anti-Cavitation Valve	01	30	Refer to ★

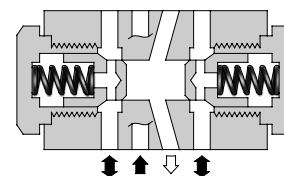

★ Design Standards: None Japanese Standard "JIS" and European Design Standard
90 N. American Design Standard

Graphic Symbol

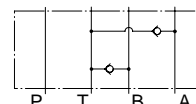

Pressure Drop

Hydraulic Fluid: Viscosity 35 mm²/s (164 SSU),
Specific Gravity 0.850

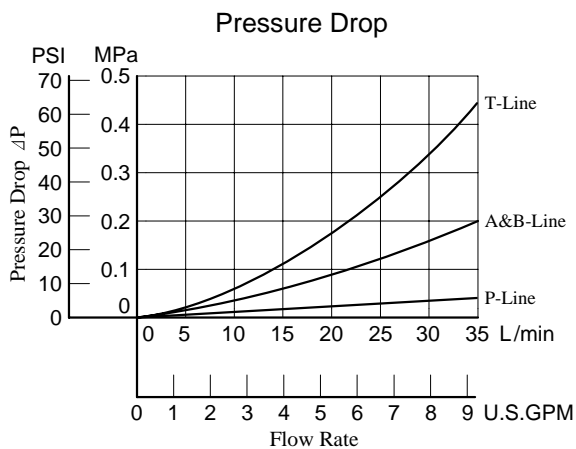

MAC-01-30/3090

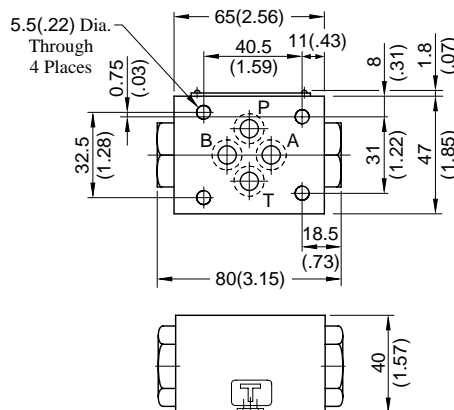

DIMENSIONS IN MILLIMETRES (INCHES)

Approx. Mass.....0.8 kg (1.8 lbs.)

MAC-01-30/3090

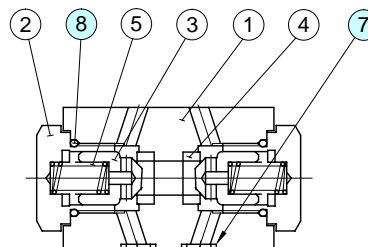

List of Seals

Item	Name of Parts	Part Numbers	Qty.	Remarks
7	O-Ring	SO-NB-P9	4	Included in Seal Kit
8	O-Ring	SO-NB-P18	2	Kit No.: KS-MAC-01-30

CAUTION

When making replacement of seals, please do it carefully after reading through the relevant instructions in the Operator's Manual.



Specifications / Others

Specifications

Model Numbers	Max. Operating Pressure MPa (PSI)	Max. Flow L/min (U.S.GPM)
MPA-01-*-40/4090 MPB-01-*-40/4090 MPW-01-*-40/4090	31.5 (4570)	35 (9.25)



Model Number Designation

F-	MPA	-01	-2	-40	*
Special Seals	Series Number	Valve Size	Cracking Pressure MPa (PSI)	Design Number	Design Standard
F: Special Seals for Phosphate Ester Type Fluids (Omit if not required)	MPA : Pilot Operated Check Valve for A-Line MPB : Pilot Operated Check Valve for B-Line MPW : Pilot Operated Check Valve for A&B-Lines	01	2 : 0.2 (29) 4 : 0.4 (58)	40	Refer to ★

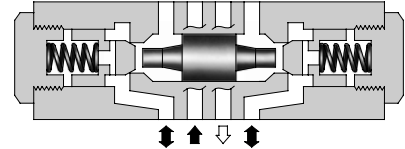

★ Design Standards: None Japanese Standard "JIS" and
 European Design Standard
 90 N. American Design Standard

Graphic Symbols

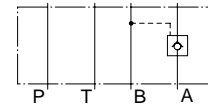

MPA-01

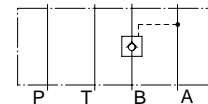

MPB-01

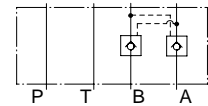

MPW-01

Typical Performance Characteristics

Hydraulic Fluid: Viscosity 35 mm²/s (164 SSU),
 Specific Gravity 0.850

Pressure Drop for Free Flow

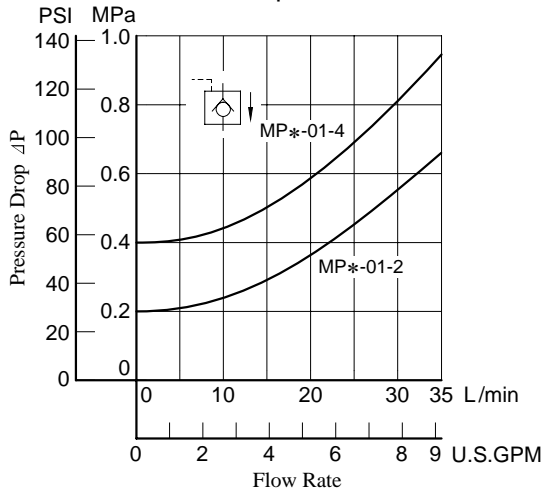

Pressure Drop for Reversed Controlled Flow

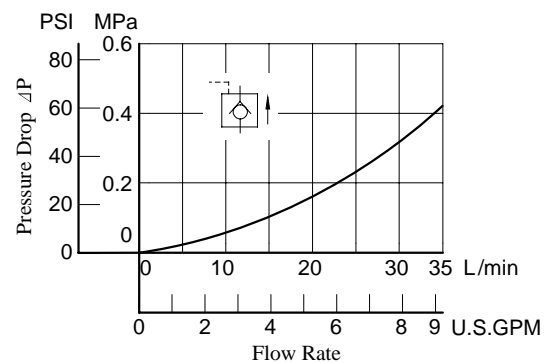

Pressure Drop

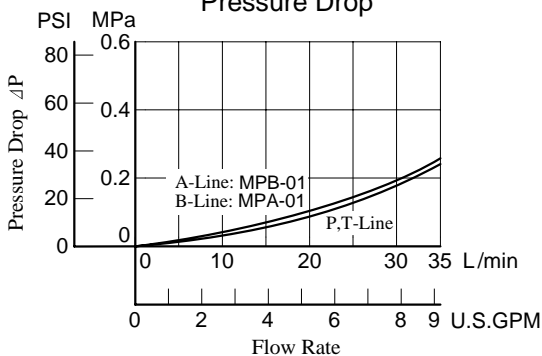

Min. Pilot Pressure

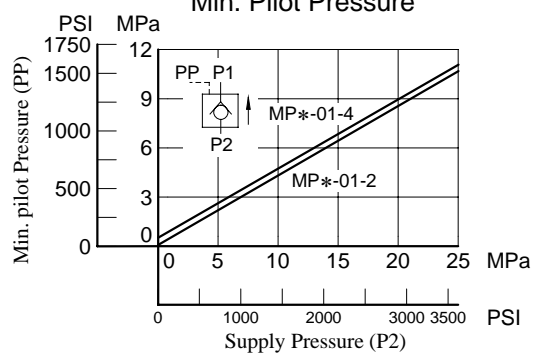

MPA-01-*-40/4090
MPB-01-*-40/4090
MPW-01-*-40/4090

DIMENSIONS IN
MILLIMETRES (INCHES)

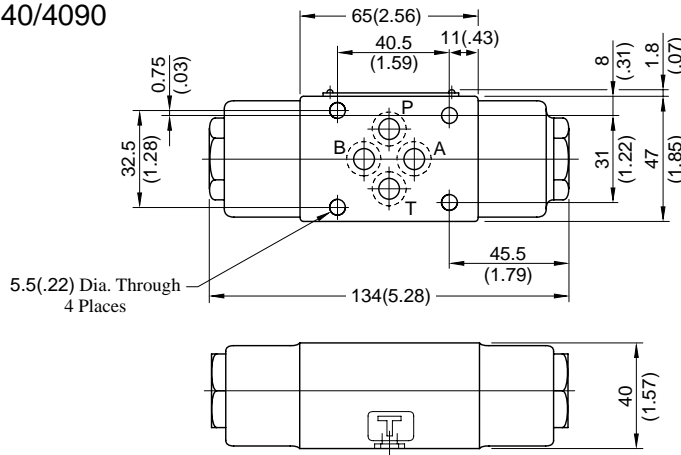

Approx. Mass..... 1.2 kg (2.6 lbs.)

■ Spare Parts List

MPW-01-*-40/4090

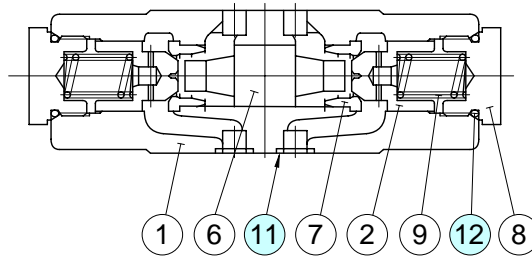

MPA-01-*-40/4090

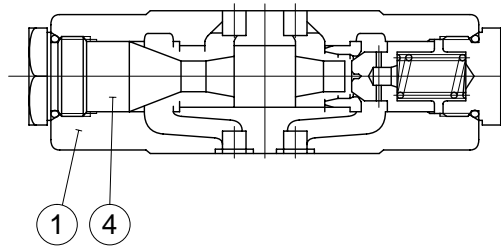

MPB-01-*-40/4090

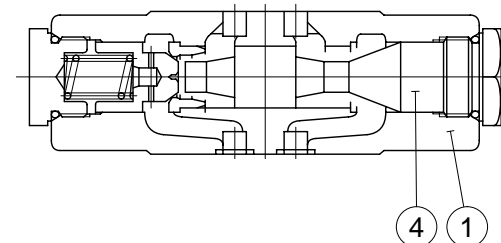

● List of Seals

Item	Name of Parts	Part Numbers	Qty.	Remarks
11	O-Ring	SO-NB-P9	4	Included in Seal Kit
12	O-Ring	SO-NB-P18	2	Kit No.: KS-MAC-01-30



CAUTION

When making replacement of seals, please do it carefully after reading through the relevant instructions in the Operator's Manual.

Blocking plates are used for auxiliary mounting surface or for closing unnecessary circuits.

Bypass plates are used for unidirectional circuits that require no solenoid operated directional valves.



Specifications

Model Number	Max. Operating Pressure MPa (PSI)	Max. Flow L/min (U.S.GPM)
MDC-01-*-30/3090	31.5 (4570)	35 (9.25)

Graphic Symbols



MDC-01-A

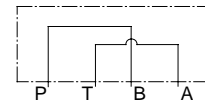

MDC-01-B

Model Number Designation

F-	MDC	-01	-A	-30	*
Special Seals	Series Number	Plate Size	Type of Plate	Design Number	Design Standard
F: Special Seals for Phosphate Ester Type Fluids (Omit if not required)	MDC: End Plate	01	A: Blocking Plate B: Bypass Plate	30	Refer to ★

★ Design Standards: None Japanese Standard "JIS" and European Design Standard
90 N. American Design Standard

Typical Performance Characteristics

Hydraulic Fluid: Viscosity 35 mm²/s (164 SSU),
Specific Gravity 0.850

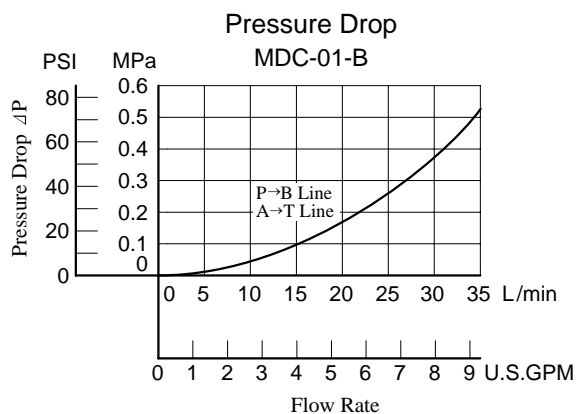

MDC-01-*-30/3090

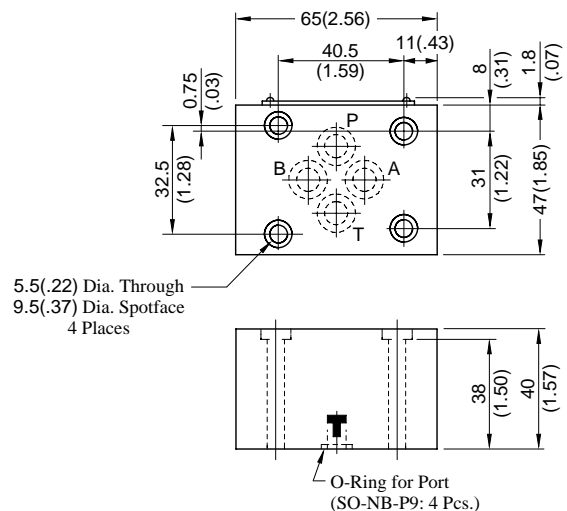

**DIMENSIONS IN
MILLIMETRES (INCHES)**

Approx. Mass.....0.8 kg (1.8 lbs.)

These plates are used for detecting pressure of each line.

Specifications

Model Number	Max. Operating Pressure MPa (PSI)	Max. Flow L/min (U.S.GPM)
MDS-01-*-30/3090	31.5 (4570)	35 (9.25)



Model Number Designation

F-	MDS	-01	-PA	-30	*
Special Seals	Series Number	Plate Size	Type of Detecting Line	Design Number	Design Standard
F : Special Seals for Phosphate Ester Type Fluids (Omit if not required)	MDS : Connecting Plate	01	PA : P&A-Line PB : P&B-Line AT : A&T-Line	30	Refer to ★

★ Design Standards: None Japanese Standard "JIS" and European Design Standard
90 N. American Design Standard

Pressure Drop

Hydraulic Fluid: Viscosity 35 mm²/s (164 SSU),
Specific Gravity 0.850

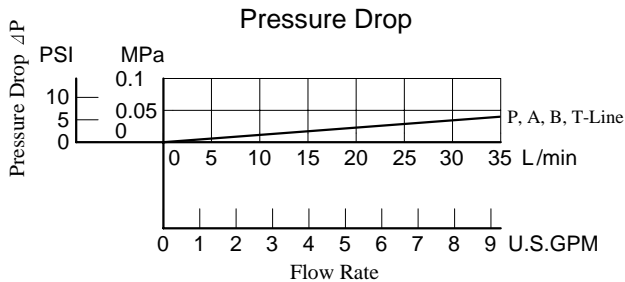

Graphic Symbols

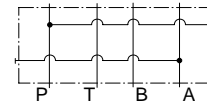

MDS-01-PA

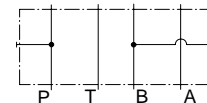

MDS-01-PB

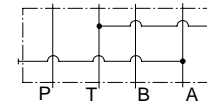

MDS-01-AT

MDS-01-*-30/3090

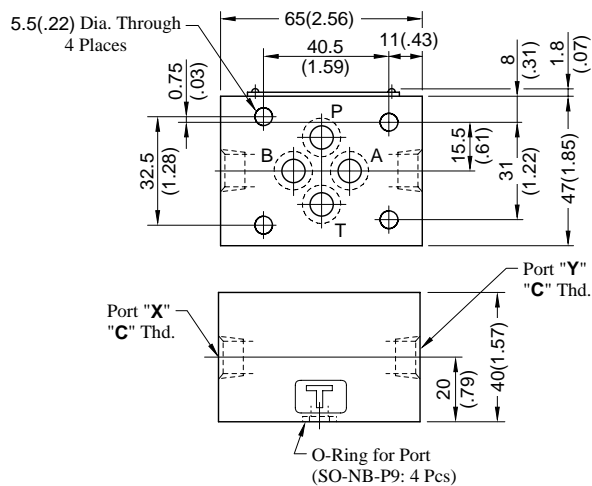

Approx. Mass..... 0.8 kg (1.8 lbs.)

Model Numbers	Pressure Detecting Line	
	Port "X"	Port "Y"
MDS-01-PA	P-Line	A-Line
MDS-01-PB	B-Line	P-Line
MDS-01-AT	T-Line	A-Line

Model Numbers	Piping Size "C" Thd.
MDS-01-*-30	Rc 1/4 = 1/4 BSP.Tr
MDS-01-*-3090	1/4 NPT

**DIMENSIONS IN
MILLIMETRES (INCHES)**

■ Specifications

Max. Operating Pressure ----- 25 MPa (3630 PSI)

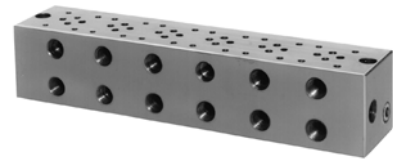

■ Model Number Designation

MMC	-01	-6	-40	*
Series Number	Plate Size	Number of Stations	Design Number	Design Standard
MMC : Base Plate	01	1 : 1 Station	40	None : Japanese Standard "JIS" 80 : European Design Standard 90 : N.American Design Standard
		2 : 2 Stations		
		3 : 3 Stations		
		4 : 4 Stations		
		5 : 5 Stations		
		6 : 6 Stations		
		7 : 7 Stations		
		8 : 8 Stations		
		9 : 9 Stations		
		10 : 10 Stations		

■ Pressure Drop

Hydraulic Fluid: Viscosity 35 mm²/s (164 SSU), Specific Gravity 0.850

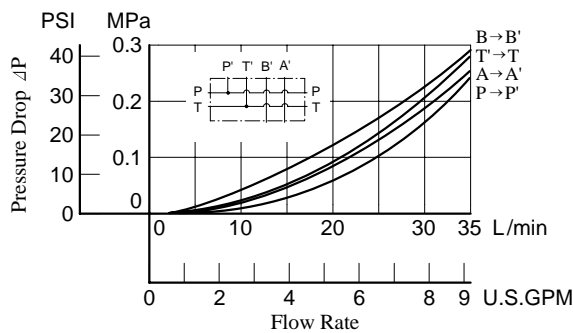

Graphic Symbols

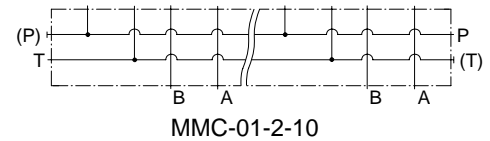
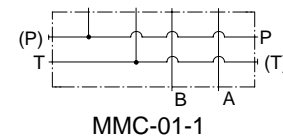

■ Instructions

- **Port Used:** Base plate has three (two, in case of 1 station type) **pressure port "P"**'s and four **tank port "T"**'s. Any one of these ports or two or more ports may be used. However, please note that the ports marked with (P) or (T) in the drawing are normally plugged. Remove the plugs when using such ports. Make sure that ports that are not currently used are properly plugged.

■ Interface Mounting Surface Dimensions for 1/8 Modular Valve

When standard base plates (MMC-01) are not used, the mounting surface described on right must be prepared. The mounting surface should have a good machined finish.

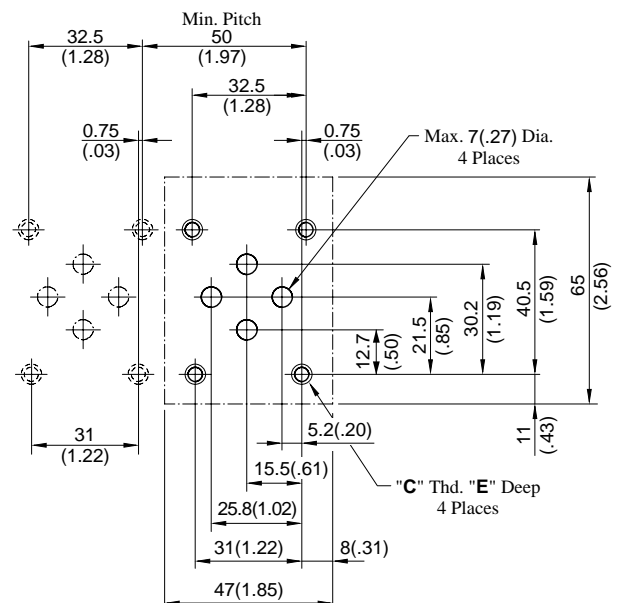

DIMENSIONS IN
MILLIMETRES (INCHES)

Design Std.	"C" Thd.	E
Japanese Standard "JIS" and European Design Standard	M5	10 (.39)
N.American Design Standard	No. 10-24 UNC	12 (.47)

MMC-01-1-40/4090

**DIMENSIONS IN
MILLIMETRES (INCHES)**

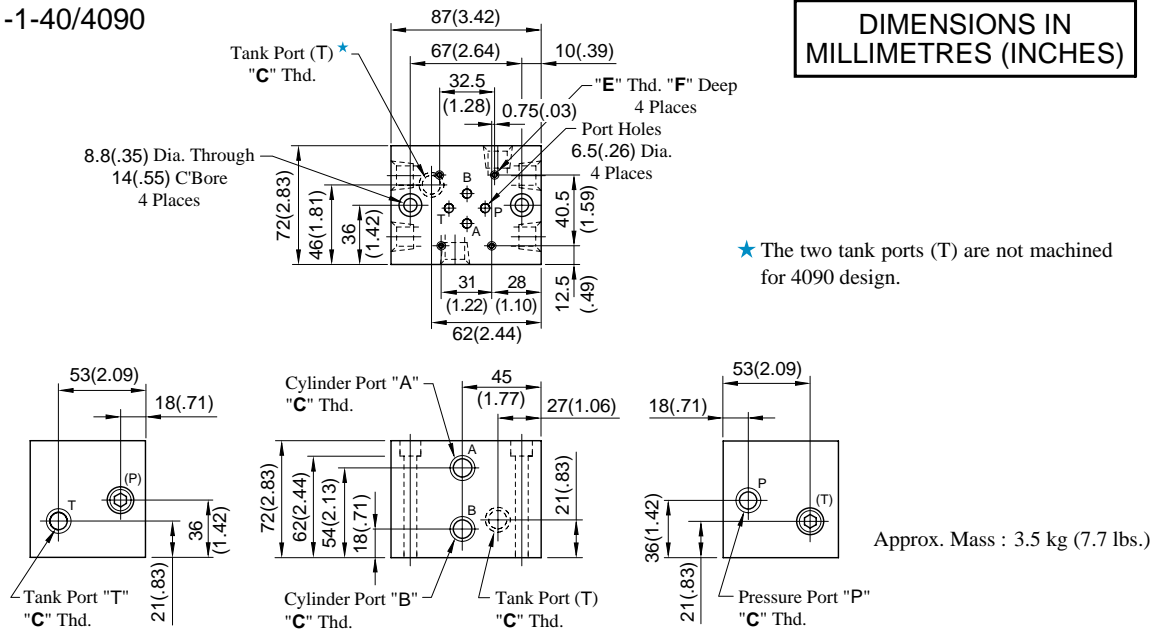

MMC-01-*40/4090

Number of Station
(2-10 Stations)

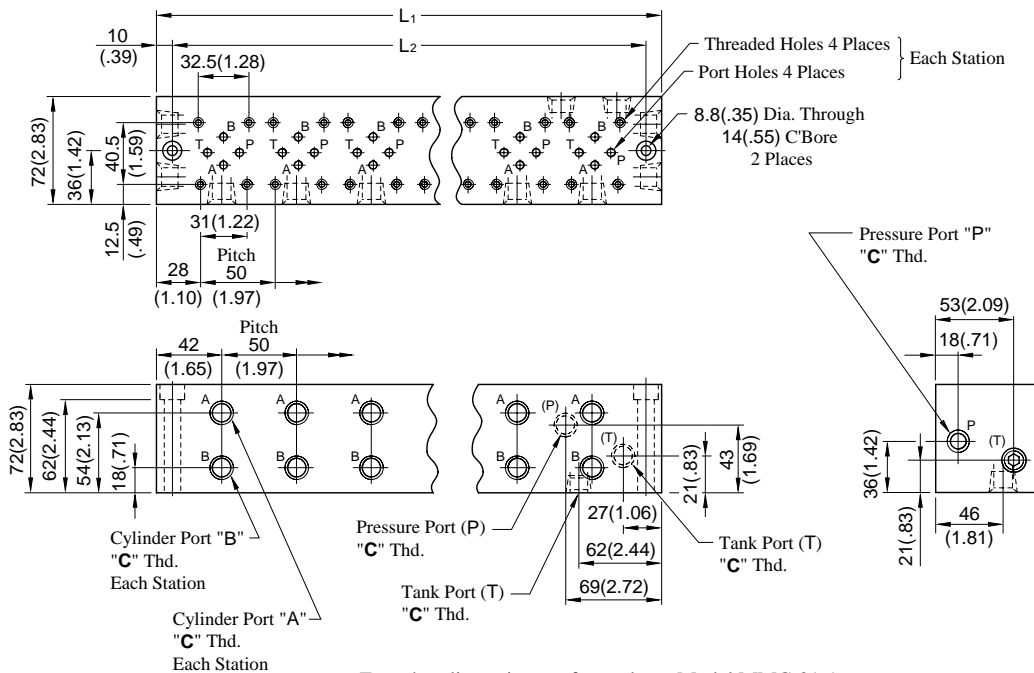

Model Numbers	Thread Size		Dimensions mm (Inches)	
	"C" Thd.	"D" Thd.	"E" Thd.	F
MMC-01-*40	Rc 3/8	Rc 1/2	M5	10 (.39)
MMC-01-*4090	3/8 NPT	1/2 NPT	No.10-24 UNC	12 (.47)

Model Numbers	Dimensions mm (Inches)		Approx. Mass kg (lbs.)	Model Numbers	Dimensions mm (Inches)		Approx. Mass kg (lbs.)
	L1	L2			L1	L2	
MMC-01-2	137 (5.39)	117 (4.61)	5.5 (12.1)	MMC-01-7	387 (15.24)	367 (14.45)	13.0 (28.7)
MMC-01-3	187 (7.36)	167 (6.57)	7.0 (15.4)	MMC-01-8	437 (17.20)	417 (16.42)	14.5 (32.0)
MMC-01-4	237 (9.33)	217 (8.54)	8.5 (18.7)	MMC-01-9	487 (19.17)	467 (18.39)	16.0 (35.3)
MMC-01-5	287 (11.30)	267 (10.51)	10.0 (22.1)	MMC-01-10	537 (21.14)	517 (20.35)	17.5 (38.6)
MMC-01-6	337 (13.27)	317 (12.48)	11.5 (25.4)				

MMC-01-1-4080

**DIMENSIONS IN
MILLIMETRES (INCHES)**

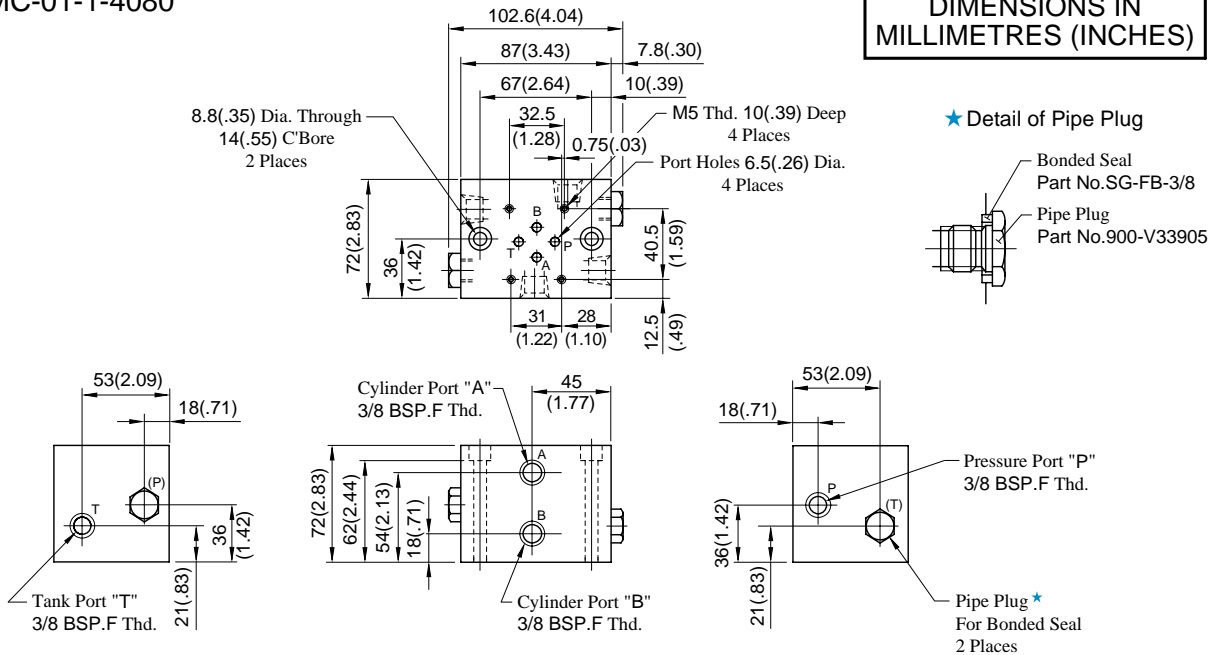

Approx. Mass : 3.5 kg (7.7 lbs.)

MMC-01-*-4080

Number of Station
(2-10 Stations)

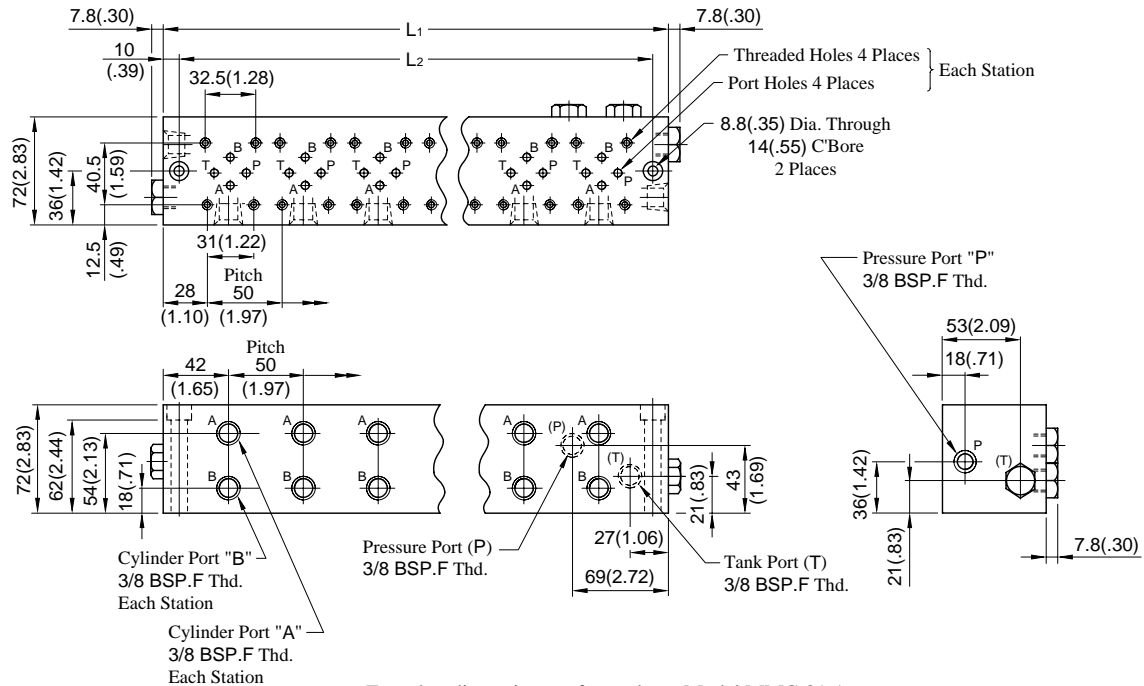

• For other dimensions, refer to above Model MMC-01-1.

Model Numbers	Dimensions mm (Inches)		Approx. Mass kg (lbs.)	Model Numbers	Dimensions mm (Inches)		Approx. Mass kg (lbs.)
	L ₁	L ₂			L ₁	L ₂	
MMC-01-2	137 (5.39)	117 (4.61)	5.5 (12.1)	MMC-01-7	387 (15.24)	367 (14.45)	13.0 (28.7)
MMC-01-3	187 (7.36)	167 (6.57)	7.0 (15.4)	MMC-01-8	437 (17.20)	417 (16.42)	14.5 (32.0)
MMC-01-4	237 (9.33)	217 (8.54)	8.5 (18.7)	MMC-01-9	487 (19.17)	467 (18.39)	16.0 (35.3)
MMC-01-5	287 (11.30)	267 (10.51)	10.0 (22.1)	MMC-01-10	537 (21.14)	517 (20.35)	17.5 (38.6)
MMC-01-6	337 (13.27)	317 (12.48)	11.5 (25.4)				

Valves are mounted with four stud bolts. Valve combination varies according to the circuit type. Hence, the mounting bolt kits are available on a combination type basis.

When ordering the bolt kit, be sure to give the bolt kit model number from the table below.

Model Number Designation

MBK	-01	-02	-30	*
Series Number	Size of Modular Valve	Bolt Number	Design Number	Design Standard
MBK: Bolt Kits for Modular Valves	01	01, 02, 03, 04, 05 (Refer to the following chart)	30	Refer to ★

★ Design Standards: None Japanese Standard "JIS" and European Design Standard 90 N. American Design Standard

Bolt Kits Selection Chart

Model Numbers	Quantity of valves to be stacked			Approx. Mass g (lbs.)
	Solenoid Operated Directional Valve (*-DSG-01)	End Plate (MDC-01)	Modular Valve & Connecting Plate	
MBK-01-01-30*	1 0	0 1	1	60(.13)
MBK-01-02-30*	1 0	0 1	2	100(.22)
MBK-01-03-30*	1 0	0 1	3	130(.29)
MBK-01-04-30*	1 0	0 1	4	160(.35)
MBK-01-05-30*	1★ 0	0 1	0	40(.09)

★ The solenoid operated directional valve comes with mounting bolts.



Bolt Kit Composition

Stud Bolt ----- 4 Pcs. } 1 Set
Nut ----- 4 Pcs. }

Note: In case of bolt kit model number having "05", 4 hexagon socket head cap screws only.

Tightening Torque:

Operating Pressure MPa (PSI)	Tightening Torque Nm (in. lbs.)
Less Than 25(3630)	5 ~ 6 (44 ~ 53)
More Than 25(3630)	6 ~ 7 (53 ~ 62)

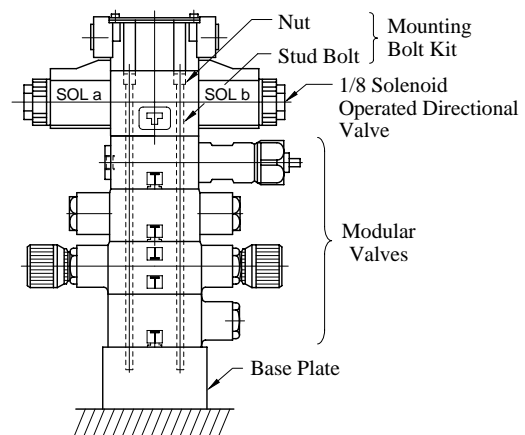

01 Series Modular Valve Assembly

MBK-01-01/02/03/04-30/3090

Stud Bolt

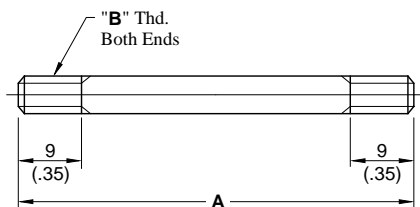

Nut

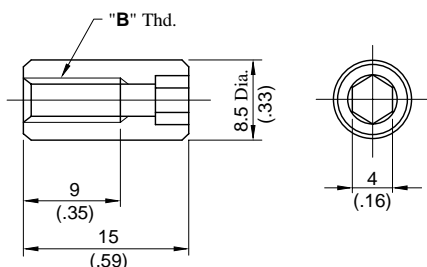

MBK-01-05-30/3090

Socket Head Cap Screw

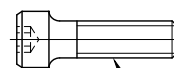

MBK-01-05-30: M5×45 Lg.
MBK-01-05-3090: No.10-24 UNC x1-3/4 Lg.

DIMENSIONS IN
MILLIMETRES (INCHES)

Model Numbers	A mm (In.)	"B" Thd.
MBK-01-01-30	94 (3.70)	M5
MBK-01-02-30	134 (5.28)	
MBK-01-03-30	174 (6.85)	
MBK-01-04-30	214 (8.43)	
MBK-01-01-3090	94 (3.70)	No.10-24 UNC
MBK-01-02-3090	134 (5.28)	
MBK-01-03-3090	174 (6.85)	
MBK-01-04-3090	214 (8.43)	