



EH series Direct Operated and High Response Type Proportional Electro-Hydraulic Directional and Flow Control Valve

ELDFG-01EH-**-**-**-10
 ELDFG-03EH-**-**-**-10

Release of New Series

We are pleased to announce the release of EH series direct operated proportional electro-hydraulic directional and flow control valves.

These valves are closed loop, high response type proportional electro-hydraulic directional and flow control valves with OBE (on board electronics). Two direct type models with a maximum rated flow rate up to 80 L/min (@ $\Delta P = 1$ MPa) are available. The addition of OBE to the well-received ELDFG series valves for simplified wiring offers simple operation and user-friendliness. With closed loop control based on a combination of newly developed compact, powerful solenoids and a LVDT for spool position detection, the valves provide high response, high accuracy, and high reliability equivalent to those of simple servo valves. The zero lap spool type (spool type 3C2L) is suitable for position or pressure control.



Graphic Symbols

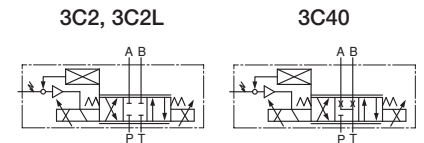



Features

- **Response Characteristics Equivalent to Those of Simple Servo Valves**
 ELDFG-01EH: 80 Hz/-90° ($\pm 25\%$ Amplitude)
 ELDFG-03EH: 50 Hz/-90° ($\pm 25\%$ Amplitude)
 These valves can be used in place of simple servo valves for position or pressure control.
- **Simple Operation and User-Friendliness**
 Only with 24 V DC power supply and command signal input, the valves allow highly accurate and fast operation of hydraulic systems.
- **Excellent Contamination Resistance**
 The valves provide excellent contamination resistance due to the powerful solenoids, thus reducing problems caused by fluid contamination as well as filtration costs.

Specifications

Item	Model Number	ELDFG-01EH			ELDFG-03EH	
		-10-3C*	-20-3C*	-35-3C*	-40-3C*	-80-3C*
Max. Operating Pressure	MPa	35				
Max. Tank Line Back Pressure	MPa	21				
Rated Flow (@ $\Delta P = 1$ MPa) (4-Way Valve)* ¹	L/min	10	20	35	40	80
Hysteresis		0.1% or less				
Repeatability		0.1% or less				
Step Response (Typical Rating)* ²	(0→100%V)	14			22	
	(100→0%V)	15			23	
Frequency Response ($\pm 25\%$ Amplitude) (Typical Rating)* ³	(Phase: -90 degree)	88			56	
	(Gain: -3 dB)	80			52	
Vibration Proof	G	10				
Protection		IP65				
Ambient Temperature	°C	-15 - +60				
Spool Stroke to Stops	mm	± 2.5			± 3	
Coil Resistance [20 °C]	Ω	3			2	
Current Consumption	A	2 (Impulse Load 3 A)				
Approx. Mass	kg	3.3			7.3	
Electric Connection		6 + PE Connector				

* 1. Use the valves so that the relationship between the valve pressure difference and the flow rate, as specified in "Range of Flow Control" on page 2, is met.
 * 2. This value is measured for each valve; it may differ depending on the actual circuit.
 * 3. There are restrictions on the mounting position. See "Mounting Position" on page 3

ELDF	G	-01	EH	-10	-3C2	-XY	-C	-D	-10
Series Number	Type of Mounting	Valve Size	Amplifier Type	Rated Flow L/min	Spool Type*1	Direction of Flow	Fail-Safe Function	Input Signal/Spool Travel Monitoring	Design Number
ELDF : Direct Operated and High Response Type Proportional Electro-Hydraulic Directional and Flow Control Valves	G : Sub-plate Mounting	01	EH : OBE Type	10 20 35	3C2 : 10% Overlap  3C40 : A, B, T Connection 	XY : Metre-In · Metre-Out	C : Neutral A : P-A, B-T Position B : P-B, A-T Position	D : Voltage Signal ±10 V (P→A→B→T Flow with Positive Input) E : Current Signal 4 - 20 mA (P→A→B→T Flow with 12 - 20 mA Input) F : Current Signal ±10 mA (P→A→B→T Flow with Positive Input)	10
		03		40 80	3C2L : 2% Overlap  (Linear Flow Gain)			10	

*1. The spool in the neutral position is shown.

*2. Phosphate ester type fluids are also supported. When phosphate ester type fluids are used, prefix "F-" to the model number because the special seals (fluororubber) are required to be used.

■ Attachment

● Mounting Bolts

Model No.	Mounting Bolt	Qty.	Tightening Torque Nm
ELDFG-01EH	Hex. Soc. Head Cap Screw: M5 × 45L	4	6 - 8
ELDFG-03EH	Hex. Soc. Head Cap Screw: M6 × 35L	4	13 - 16

Note) The connector is separately available. Use a 6 + PE connector [EN175201 Part 804].

■ Range of Flow Control

● Control Method: 4-Way Valve

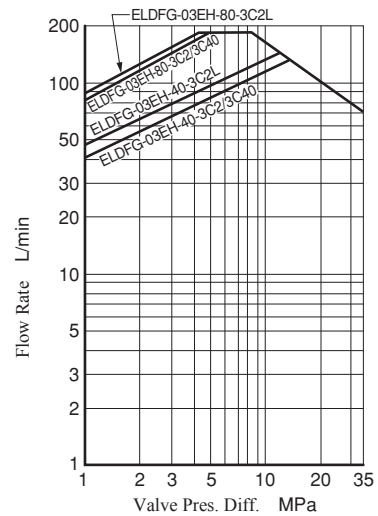
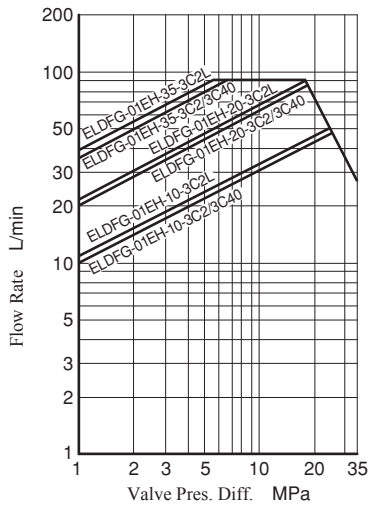
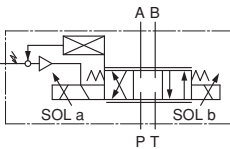

● Control Method: 3-Way Valve

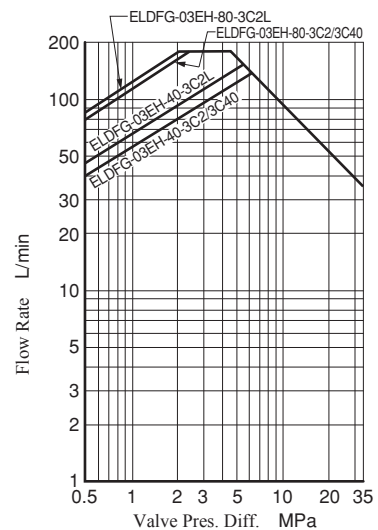
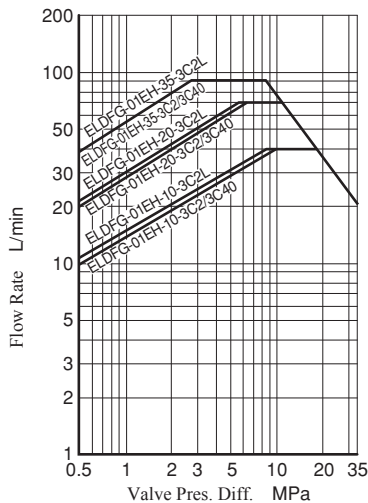
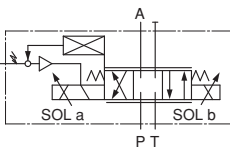

Model Number Designation

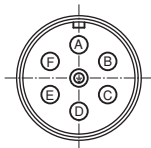

Valve Model		ELDFG- *EH- * -D	ELDFG- *EH- * -E	ELDFG- *EH- * -F
Pin A	Power Supply	24 V DC (21.6 - 26.4 V DC Included Ripple), 75 VA or more		
Pin B		0 V		
Pin C	Signal Common	COM (0 V)		
Pin D	Input (+) (Differential)* ¹	0 - ±10 V	4 - 20 mA	0 - ±10 mA
Pin E	Input (-) (Differential)* ¹	R _i ≥ 50 kΩ	R _i = 200 Ω	R _i = 200 Ω
Pin F	Spool Travel Monitoring	0 - ±10 V	4 - 20 mA	0 - ±10 mA
		R _i ≥ 10 kΩ	R _i = 100 - 500 Ω* ²	R _i = 100 - 500 Ω* ²
Pin	Protective Earth	—		

* 1. Differential input signals can be used only for the valves with the voltage signal specifications of ±10 V (ELDFG- *EH- * -D).

* 2. The recommended load resistance is 200 Ω.

I/O Signal Characteristics

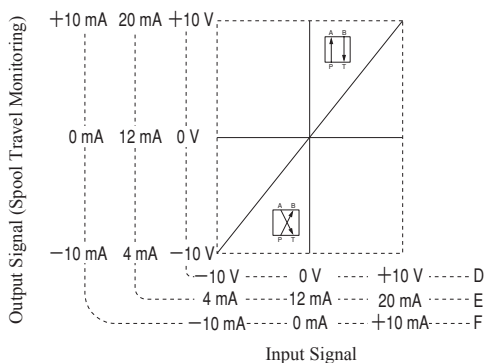

Block Diagram

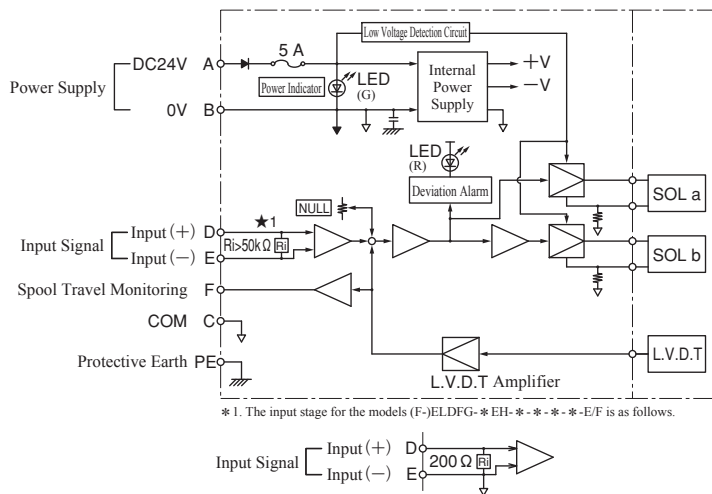

Mounting Position

Mount the valve with the angle of the axis line L-L' within about ±15° from the horizontal plane, as shown in the right figures. If the axial direction of the spool corresponds to the principal vibration direction, an external force may cause the spool to malfunction. The valve must be mounted in such a way that the axial direction of the spool does not correspond to the principal vibration direction.

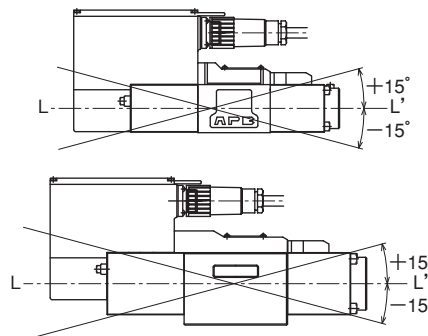

ELDFG-03EH-*-XY-***-10**

Mounting surface: Conform to ISO4401-05-04-0-94.

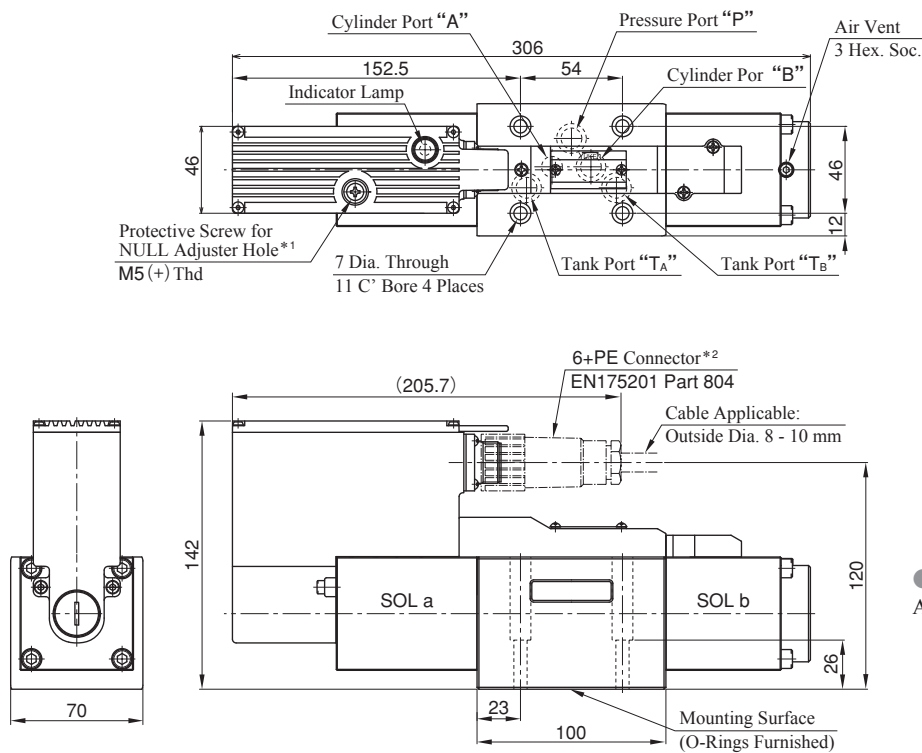

Color	Indicator Lamp
Green	Power Supply
Red	Deviation Alarm

● O-Rings for the Ports
AS568-014 (NBR, HS90): 5 Pieces

- * 1. For NULL adjustment, remove the protective screw and turn the trimmer behind the screw. After adjustment, be sure to attach the protective screw.
- * 2. The 6 + PE connector is not included with the valve. Prepare it separately.
YUKEN parts number: TK290457-1
- * 3. With standard sub-plates, one ("TA") of the two tank ports is used, but either one may be used.

[Mounting Surface]

Sub-plates are available. Specify the sub-plate model number from the table below.

Sub-Plate Model Numbers	Thread Size	Mass kg
DSGM-03-40	Rc 3/8	3
DSGM-03X-40	Rc 1/2	
DSGM-03Y-40	Rc 3/4	4.7

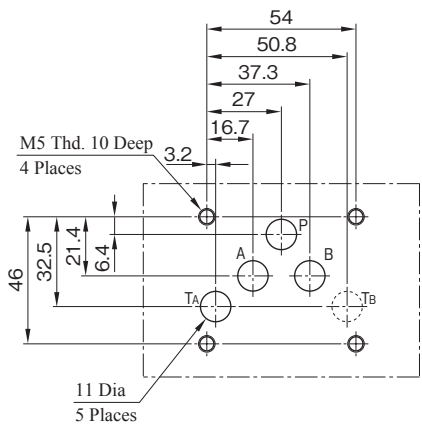

When sub-plates are not used, the mounting surface should have a good machined finish (e.g. surface roughness of 6-S). There are two tank ports "TA" and "TB". Note that the port "TA" may be used alone.

No-Load Flow Characteristics

(Conditions) ● Valve Pres. Difference: 1 MPa ● Viscosity: 30 mm²/s

ELDFG-01EH- *-3C2/3C40-XY- *- *-10

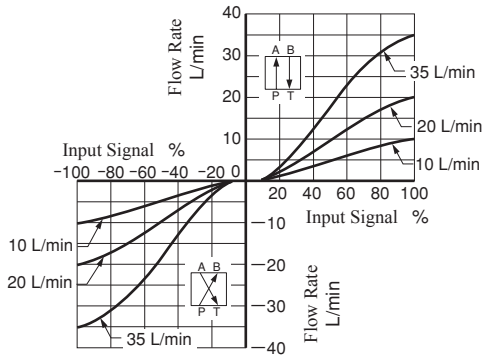

ELDFG-01EH- *-3C2L-XY- *- *-10

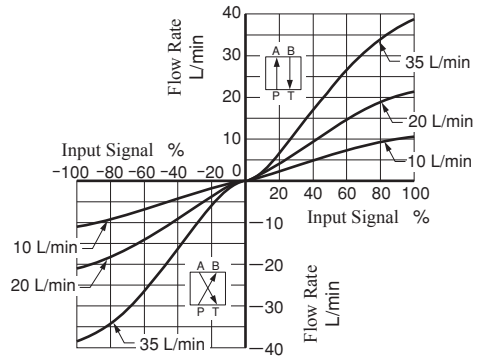

ELDFG-03EH- *-3C2/3C40-XY- *- *-10

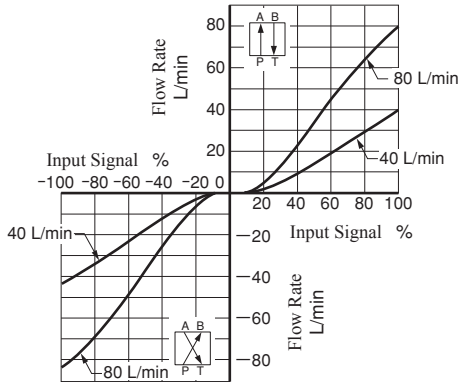

ELDFG-03EH- *-3C2L-XY- *- *-10

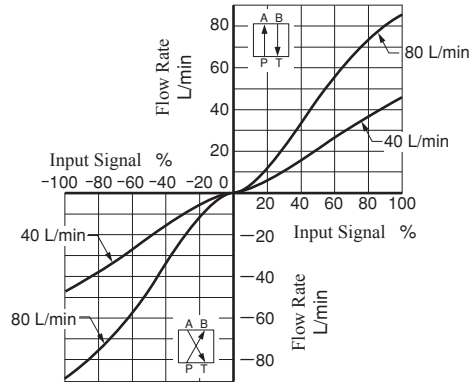

Step Response (Example)

(Conditions) ● Hydraulic Circuit: Port A/B Closed ● Input Signal: 0 ↔ 100% ● Viscosity: 30 mm²/s

This value is measured for each valve; it may differ depending on the actual circuit.

● ELDFG-01EH

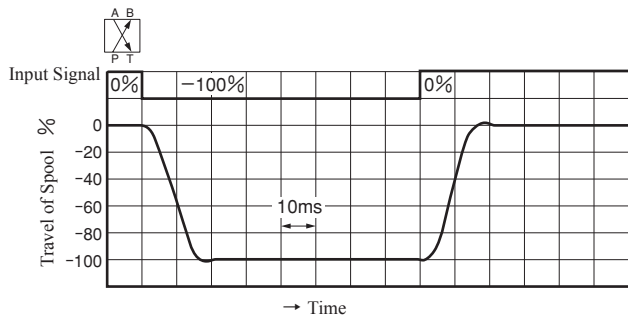
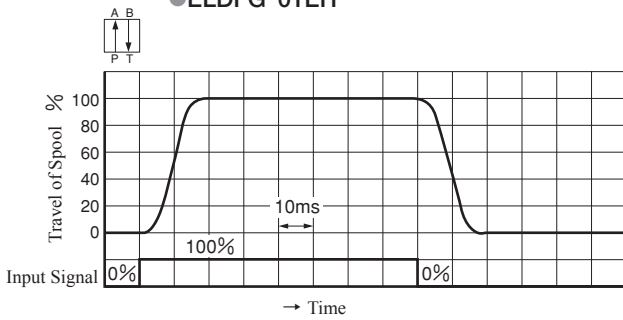

● ELDFG-03EH

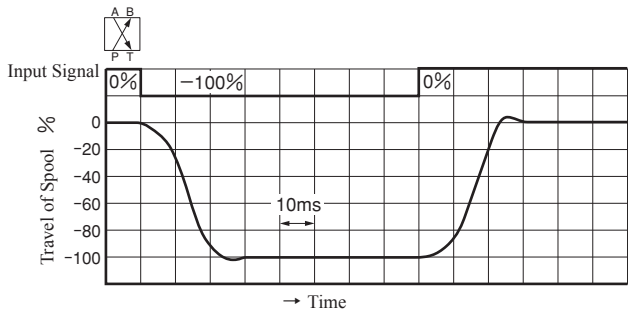
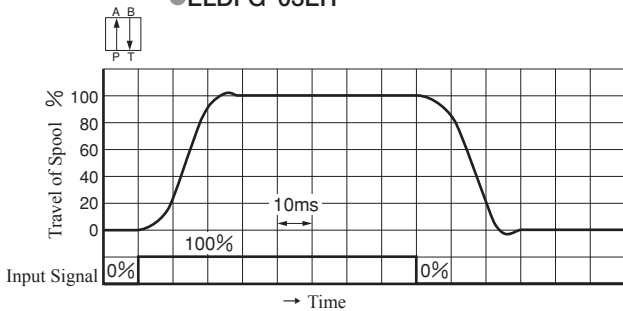

Frequency Response

〈Conditions〉 ● Hydraulic Circuit: Port A/B Closed ● Supply Pressure: 14 MPa ● Viscosity: 30 mm²/s

● ELDFG-01EH

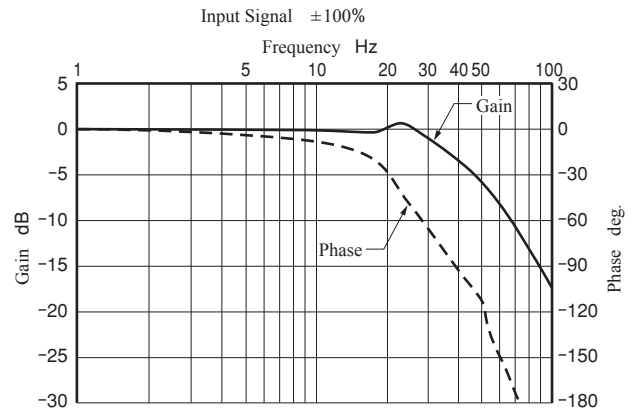
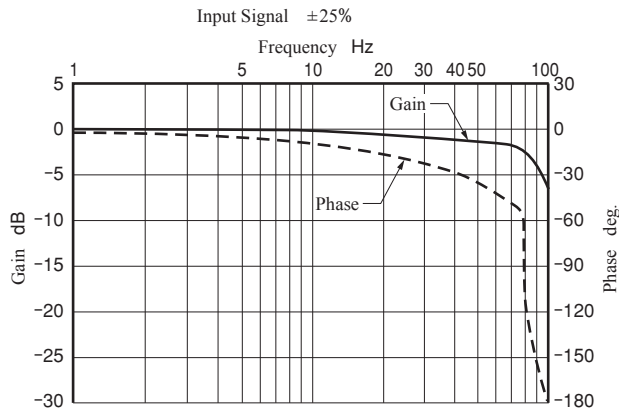

● ELDFG-03EH

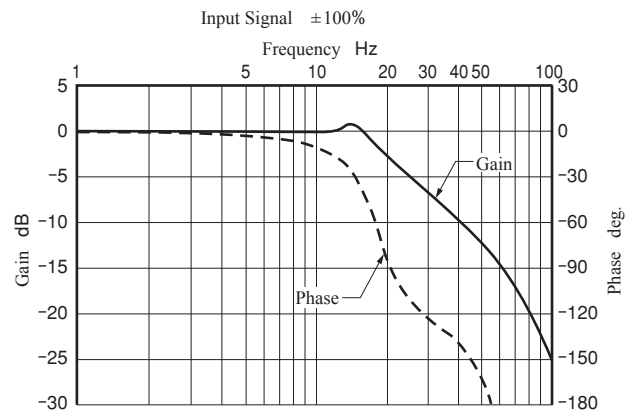
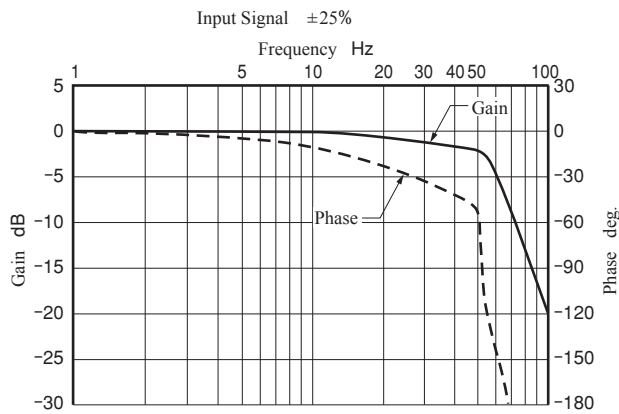

【Application】

Injection molding machine, various test equipment, and steel mill equipment.

【Product Release】

September, 2013 order start